

SIEMENS



Industrial Controls

SIRIUS Modular System

System Overview

System Manual

Edition

09/2016

Answers for industry.

SIEMENS

Industrial Controls

SIRIUS - system overview



System Manual

<u>Introduction</u>	1
<u>Safety instructions</u>	2
<u>Standards and approvals</u>	3
<u>Overview</u>	4
<u>System properties</u>	5
<u>Customer benefits</u>	6
<u>Components and combinations</u>	7
<u>Mounting and disassembly</u>	8
<u>Connection</u>	9

Legal information

Warning notice system

This manual contains notices you have to observe in order to ensure your personal safety, as well as to prevent damage to property. The notices referring to your personal safety are highlighted in the manual by a safety alert symbol, notices referring only to property damage have no safety alert symbol. These notices shown below are graded according to the degree of danger.

 DANGER
indicates that death or severe personal injury will result if proper precautions are not taken.
 WARNING
indicates that death or severe personal injury may result if proper precautions are not taken.
 CAUTION
indicates that minor personal injury can result if proper precautions are not taken.
NOTICE
indicates that property damage can result if proper precautions are not taken.

If more than one degree of danger is present, the warning notice representing the highest degree of danger will be used. A notice warning of injury to persons with a safety alert symbol may also include a warning relating to property damage.

Qualified Personnel

The product/system described in this documentation may be operated only by **personnel qualified** for the specific task in accordance with the relevant documentation, in particular its warning notices and safety instructions. Qualified personnel are those who, based on their training and experience, are capable of identifying risks and avoiding potential hazards when working with these products/systems.

Proper use of Siemens products

Note the following:

 WARNING
Siemens products may only be used for the applications described in the catalog and in the relevant technical documentation. If products and components from other manufacturers are used, these must be recommended or approved by Siemens. Proper transport, storage, installation, assembly, commissioning, operation and maintenance are required to ensure that the products operate safely and without any problems. The permissible ambient conditions must be complied with. The information in the relevant documentation must be observed.

Trademarks

All names identified by ® are registered trademarks of Siemens AG. The remaining trademarks in this publication may be trademarks whose use by third parties for their own purposes could violate the rights of the owner.

Disclaimer of Liability

We have reviewed the contents of this publication to ensure consistency with the hardware and software described. Since variance cannot be precluded entirely, we cannot guarantee full consistency. However, the information in this publication is reviewed regularly and any necessary corrections are included in subsequent editions.

Table of contents

1	Introduction.....	9
1.1	Preface	9
1.2	Siemens Industry Online Support	10
1.3	DataMatrix code	12
1.4	Security information.....	13
1.5	Recycling and disposal.....	13
1.6	Technical Assistance.....	13
2	Safety instructions	15
3	Standards and approvals.....	17
3.1	Standards.....	17
3.2	IE3 / IE4 ready	19
4	Overview.....	21
4.1	SIRIUS modular system	21
4.2	Manuals - SIRIUS Modular System.....	26
5	System properties	29
5.1	System properties	29
5.2	Modular system design.....	30
5.3	Switching technology.....	32
5.4	Uniform connection system.....	35
5.5	Flexible assembly methods.....	36
5.6	Performance capability	37
5.7	Assembly and mounting	37
5.8	Load feeders	38
5.9	Application monitoring	40
5.10	Industrial communication	41
5.10.1	Communication overview.....	41
5.10.2	IO-Link	44
5.10.2.1	Overview.....	44
5.10.2.2	System components.....	46
5.10.2.3	Benefits.....	50
5.10.2.4	Applications.....	51
5.10.2.5	More information	52
5.10.3	AS-Interface	53
5.10.3.1	Overview.....	53

5.10.3.2	System components.....	54
5.10.3.3	Benefits.....	55
5.10.3.4	Application	56
5.10.3.5	More information	57
5.11	Safety applications	58
5.12	Environmental protection.....	58
5.13	Energy efficiency.....	59
5.13.1	Energy efficiency.....	59
5.13.2	Acquisition of measured energy values.....	59
5.13.3	Reduction in intrinsic power losses.....	60
5.13.4	Optimal drive solution.....	62
5.13.5	Energy efficiency examples.....	63
6	Customer benefits.....	65
6.1	Customer benefits	65
7	Components and combinations.....	69
7.1	Switching and starting	69
7.1.1	SIRIUS 3RT contactors	69
7.1.1.1	Overview of the contactor range	69
7.1.1.2	Device versions.....	73
7.1.1.3	Applications.....	74
7.1.1.4	SIRIUS 3RT2 contactors	76
7.1.1.5	SIRIUS 3RT1 contactors	85
7.1.2	3RA27/3RA28 function modules.....	89
7.1.2.1	3RA27 function modules for connection to the higher-level control.....	90
7.1.2.2	SIRIUS 3RA28 function modules for mounting on 3RT2 contactors	94
7.1.3	3RF34 solid-state switching devices	102
7.1.3.1	Device versions.....	103
7.1.3.2	Applications.....	105
7.1.4	SIRIUS 3RW30/40 soft starters	106
7.1.4.1	Applications and use	107
7.1.4.2	Fields of application.....	108
7.2	Protecting.....	111
7.2.1	SIRIUS 3RV motor starter protectors	111
7.2.1.1	Introduction	112
7.2.1.2	Versions.....	113
7.2.1.3	Applications.....	114
7.2.1.4	Performance features.....	115
7.2.1.5	Accessories for SIRIUS 3RV motor starter protectors	116
7.2.1.6	SIRIUS 3RV2917 infeed system.....	120
7.2.2	SIRIUS 3RU thermal overload relays / SIRIUS 3RB electronic overload relays	122
7.2.2.1	Introduction	124
7.2.2.2	Versions.....	126
7.2.2.3	Applications.....	128
7.2.3	3RB24 electronic overload relays for IO-Link	131
7.2.3.1	Properties	132
7.2.3.2	System structure	133
7.2.3.3	Reference	134
7.3	Monitoring	135

7.3.1	3UG4 / 3RR2 monitoring relays	135
7.3.1.1	SIRIUS 3RR2 current monitoring relays	135
7.3.1.2	Overview of the functions	139
7.3.1.3	Reference	141
7.3.2	3RS1 / 3RS2 temperature monitoring relays	142
7.3.2.1	Product description.....	142
7.3.2.2	Overview of the functions (3RS10/ 11/ 20/ 21)	143
7.3.3	3UG48 / 3RR24 monitoring relays for IO-Link	144
7.3.3.1	Product description.....	144
7.3.3.2	Overview of the functions	146
7.3.3.3	Reference	147
7.3.4	3RS14 / 3RS15 temperature monitoring relays for IO-Link	148
7.3.4.1	Product description.....	148
7.3.4.2	Overview of the functions	150
7.4	Feeders and tested switchgear assemblies.....	151
7.4.1	SIRIUS 3RA load feeders	151
7.4.1.1	Overview	151
7.4.1.2	Device versions	151
7.4.1.3	SIRIUS 3RA21/22 load feeders	155
7.4.1.4	SIRIUS 3RA21/22 pre-assembled load feeders	156
7.4.1.5	Self-assembled load feeders	156
7.4.1.6	Applications.....	158
7.4.2	Device combinations	159
7.4.3	SIRIUS 3RA6 compact starters.....	161
7.4.3.1	System overview	162
8	Mounting and disassembly	169
8.1	Screw mounting	169
8.2	Snap-on mounting	170
9	Connection	173
9.1	Connection systems	173
9.1.1	Screw connection	173
9.1.2	Spring-loaded connection	174
9.1.3	Ring cable lug connection.....	180
9.2	Conductor cross-sections	181
9.2.1	Conductor cross-sections for screw-type connection systems	181
9.2.2	Conductor cross-sections for spring-loaded connection systems.....	192
9.2.3	Conductor cross-sections for ring cable lug connection system.....	194
9.3	CAX data	198
	Glossary.....	199
	Index	215

Introduction

1.1 Preface

Purpose of this manual

The information in this manual provides you with an overview of the SIRIUS modular system.

The SIRIUS modular system consists of the following devices:

- 3RT contactors, 3RH contactor relays and 3RA contactor assemblies
- 3RF solid-state switching devices
- 3RW soft starters
- 3RV motor starter protectors
- 3RU thermal overload relays
- 3RB electronic overload relays
- 3RR current monitoring relays
- 3RA feeders and tested switchgear assemblies

The relevant manuals are needed for configuring and commissioning the devices.

Basic knowledge required

To understand these operating instructions you should have a general knowledge of automation engineering and low-voltage controls.

Validity

The system manual is valid for the devices belonging to the SIRIUS modular system. It contains a description of the devices in the SIRIUS modular system that are valid at the time of publication.

1.2 Siemens Industry Online Support

Information and Service

In Siemens Industry Online Support, you can obtain up-to-date information from our global support database quickly and simply. To accompany our products and systems, we offer a wealth of information and services that provide support in every phase of the lifecycle of your machine or plant – from planning and implementation, through commissioning, up to maintenance and modernization:

- Product support
- Application examples
- Services
- Forum
- mySupport

Link: Siemens Industry Online Support (<https://support.industry.siemens.com/cs/ww/en>)

Product support

You will find here all the information and comprehensive know-how covering all aspects of your product:

- **FAQs**
Our answers to frequently asked questions.
- **Manuals/operating instructions**
Read online or download, available as PDF or individually configurable.
- **Certificates**
Clearly sorted according to approving authority, type and country.
- **Characteristic curves**
For support in planning and configuring your system.
- **Product announcements**
The latest information and news concerning our products.
- **Downloads**
You can find here updates, service packs, HSPs and much more for your product.
- **Application examples**
Function blocks, background and system descriptions, performance statements, demonstration systems, and application examples, clearly explained and represented.
- **Technical data**
Technical product data for support in planning and implementing your project.

Link: Product support (<https://support.industry.siemens.com/cs/ww/en/ps>)

mySupport

With "mySupport", your personal workspace, you get the very best out of your Industry Online Support. Everything to enable you to find the right information every time.

The following functions are now available:

- **Personal messages**
Your personal mailbox for exchanging information and managing your contacts
- **Inquiries**
Use our online form for specific solution suggestions, or send your technical inquiry directly to a specialist in Technical Support
- **Notifications**
Make sure you always have the latest information - individually tailored to your needs
- **Filters**
Simple management and re-use of your filter settings from Product Support and the Technical Forum
- **Favorites / Tags**
Create your own knowledge database by assigning "Favorites" and "Tags" to documents – simply and efficiently
- **Entries last viewed**
Clear presentation of your last viewed entries
- **Documentation**
Configure your individual documentation from different manuals – quickly and without complications
- **Personal data**
Change personal data and contact information here
- **CAX data**
Simple access to thousands of items of CAX data such as 3D models, 2D dimension drawings, EPLAN macros and much more

1.3 DataMatrix code

A Data Matrix code has been lasered onto the devices in the SIRIUS modular system.

The Data Matrix codes are standardized in ISO/IEC 16022. The Data Matrix codes on Siemens devices use ECC200 coding for powerful error correction.

The following information is stored in the Data Matrix code:

1P	Article number	+	S	Location	/	Date	Serial number
Data identifier	User content	Separator	User content	Separator	User content	User content	User content

Note

The information content is displayed without spaces.

This machine-readable information simplifies and accelerates handling of the respective devices.

As well as fast access to the serial numbers of the respective devices for unique identification, the Data Matrix codes simplify communication with Siemens Technical Support.

Siemens Industry Online Support app

You can use the Siemens Industry Online Support app to access all the device-specific information available on the Siemens Industry Online Support portal for a particular article number, including operating instructions, manuals, datasheets, FAQs etc.

The Siemens Industry Online Support app is available for iOS, Android or Windows Phone devices. You can download the app from the following links:



Link for Android



Link for iOS



Link for Windows Phone

1.4 Security information

Siemens provides products and solutions with industrial security functions that support the secure operation of plants, systems, machines and networks.

In order to protect plants, systems, machines and networks against cyber threats, it is necessary to implement – and continuously maintain – a holistic, state-of-the-art industrial security concept. Siemens' products and solutions only form one element of such a concept.

Customer is responsible to prevent unauthorized access to its plants, systems, machines and networks. Systems, machines and components should only be connected to the enterprise network or the internet if and to the extent necessary and with appropriate security measures (e.g. use of firewalls and network segmentation) in place.

Additionally, Siemens' guidance on appropriate security measures should be taken into account. For more information about industrial security, please visit:
<http://www.siemens.com/industrialsecurity>

Siemens' products and solutions undergo continuous development to make them more secure. Siemens strongly recommends to apply product updates as soon as available and to always use the latest product versions. Use of product versions that are no longer supported, and failure to apply latest updates may increase customer's exposure to cyber threats.

To stay informed about product updates, subscribe to the Siemens Industrial Security RSS Feed under:
<http://www.siemens.com/industrialsecurity>

1.5 Recycling and disposal

These devices can be recycled thanks to their low pollutant content. For environmentally-friendly recycling and disposal of your electronic waste, please contact a company certified for the disposal of electronic waste.

1.6 Technical Assistance

Up-to-the-minute information

You can obtain further assistance by calling the following numbers:

Technical Assistance:

Telephone: +49 (911) 895-5900 (8 a.m. to 5 p.m. CET)

Fax: +49 (911) 895-5907

or on the Internet at:

E-mail: (<mailto:technical-assistance@siemens.com>)

Internet: (<http://www.siemens.com/sirius/technical-assistance>)

Safety instructions

Five safety rules for work in or on electrical installations

A set of rules, which are summarized in DIN VDE 0105 as the "five safety rules", are defined for work in or on electrical installations as a preventative measure against electrical accidents:

1. Isolate
2. Secure against switching on again
3. Verify that the equipment is not live
4. Ground and short-circuit
5. Erect barriers around or cover adjacent live parts

These five safety rules must be applied in the above order prior to starting work on an electrical system. After completing the work, proceed in the reverse order.

It is assumed that every electrician is familiar with these rules.

Explanations

1. The isolating distances between live and de-energized parts of the system must vary according to the operating voltage that is applied.
In electrical installations, "isolate" refers to the disconnection of all poles of live parts. Disconnection of all poles can be achieved by, for example:
 - Switching off the miniature circuit breaker
 - Switching off the motor starter protector
 - Unscrewing fuses
 - Removing LV HRC fuses
2. The feeder must be secured against inadvertent restarting to ensure that it remains isolated for the duration of the work. This can be achieved, for instance, by securing the motor starter protector and miniature circuit breaker with lockable blocking elements in the disconnected state, either using a lock or by unscrewing the fuses.
3. The deenergized state of the equipment should be verified using suitable test equipment, e.g. a two-pole voltmeter. Single-pole test pins are not suitable for this purpose. The absence of power must be established for all poles, phase to phase, and phase to N/PE.
4. Grounding and short-circuiting are only mandatory if the system has a nominal voltage greater than 1 kV. In this case, the system should always be grounded first and then connected to the live parts to be short-circuited.
5. These parts should be covered, or barriers erected around them, to avoid accidental contact during the work with adjacent parts that are still live.

Standards and approvals

3.1 Standards

The standards from Catalog IC 10 "SIRIUS Industrial Controls" in the appendix always apply. Below are some of the most important standards which apply to the devices in the SIRIUS modular system.

Standards / approvals

Table 3- 1 IEC standards

IEC	Title
IEC 60947-1	Low-voltage switchgear and controlgear - General rules
IEC 60947-2	Low-voltage switchgear and controlgear – Part 2: Circuit breakers
IEC 60947-4-1	Low-voltage switchgear and controlgear – Part 4-1: Electromechanical contactors and motor-starters
IEC 60947-4-2	Low-voltage switchgear and controlgear – Part 4-2: Contactors and motor-starters - AC semiconductor motor controllers and starters
IEC 60947-4-3	Low-voltage switchgear and controlgear – Part 4-3: Contactors and motor-starters - AC semiconductor controllers and contactors for non-motor loads
IEC 60947-5-1	Low-voltage switchgear and controlgear – Part 5-1: Control circuit devices and switching elements - Electromechanical control circuit devices
IEC 60947-6-2	Low-voltage switchgear and controlgear – Part 6-2: Multiple function equipment. Control and protective switching devices (or equipment)

3.1 Standards

Table 3- 2 UL standards

UL	Title
UL 60947-1	Low-Voltage Switchgear and Control gear - Part 1: General rules
UL 60947-4-1	Low-Voltage Switchgear and Control gear - Part 4-1: Contactors and motor-starters - Electromechanical contactors and motor-starters
UL 489	Molded-Case Circuit Breakers, Molded-Case Switches and Circuit-Breaker Enclosures

Table 3- 3 CSA standards

CSA	Title
CSA-C22.2 No. 14-13	Industrial Control Equipment
CAN/CSA-C22.2 No 60947-1-13	Low-Voltage Switchgear and Control gear - Part 1: General rules
CAN/CSA-C22.2 No 60947-4-1-14	Low-Voltage Switchgear and Control gear - Part 4-1: Contactors and motor-starters - Electromechanical contactors and motor-starters

Table 3- 4 CCC standard

CCC	Title
CCC	Certificate for China Compulsory Product Certification

Approvals, test certificates, characteristics

You can find an overview of the certifications available for low-voltage controls and distribution products and other technical documentation, updated daily, on the Internet (<https://support.industry.siemens.com/cs/ww/en/ps/16027/cert>).

3.2 IE3 / IE4 ready

Ambitious climate protection goals in Europe call for increasingly energy-efficient components.

With this in mind, the energy efficiency class IE3 / IE4 has been mandatory since January 2015 (with exceptions) for three-phase asynchronous motors, and this will have an effect on motors, low-voltage power distribution systems, and industrial controls.

This applies:

- Since January 1, 2015 for motors from 7.5 kW to 375 kW
- From January 1, 2017 for motors from 0.75 kW to 375 kW

You will be optimally equipped for the current motor generation with the SIRIUS modular system components and 3VA molded case circuit breakers.

You will find information on IE3 / IE4 at:

Information IE3 (<http://www.siemens.com/IE3ready>)



Note

Using SIRIUS controls with IE3 / IE4 motors

For the use of SIRIUS controls in conjunction with highly energy-efficient IE3 / IE4 motors, please observe the information on dimensioning and configuring in the "Application Manual - SIRIUS Controls with IE3 / IE4 Motors

(<https://support.industry.siemens.com/cs/ww/en/view/94770820>)".

Overview

4.1 SIRIUS modular system

SIRIUS modular system

The SIRIUS modular system comprises devices for use in switching, starting, protecting, and monitoring, as well as combinations thereof.

Device	Performance range / adjustable current range
3RT contactors	3 ... 250 kW (P / AC-3 / 400 V)
3RH contactor relays	Switching in the control circuit
3RF solid-state switching devices	2.2 ... 7.5 kW (P / U _e / 400 V)
3RW soft starters	1.5 ... 250 kW (P / U _e / 400 V)
3RV motor starter protectors	0.11 ... 100 A
3RU thermal overload relays	0.11 ... 100 A
3RB electronic overload relays	0.1 ... 630 A
3RR current monitoring relays	1.6 ... 80 A

The devices named above are supplemented for the main circuit by devices for the control circuit: 3RA28 function modules for mounting on 3RT2 contactors and 3RA27 function modules for connection to the higher-level control.

4.1 SIRIUS modular system

Switching and starting

Table 4- 1 Function - switching and starting - contactors

Size						
S00	S0	S2	S3	S6	S10	S12
						

Table 4- 2 Function - switching and starting - solid-state switching devices







Size	
S00	S0
	

Table 4- 3 Function - switching and starting - soft starters

Size					
S00	S0	S2	S3	S6	S10 / S12
					

Protecting

Table 4- 4 Function - protecting - motor starter protectors





Size						
S00	S0	S2	S3	S6	S10	S12
				—	—	—

Table 4- 5 Function - protecting - electronic overload relays













Size					
S00	S0	S2	S3	S6	S10 / S12
					

Table 4- 6 Function - protecting - thermal overload relays

Size						
S00	S0	S2	S3	S6	S10	S12
				—	—	—

Monitoring

Table 4- 7 Function - monitoring - current monitoring relays

Size						
S00	S0	S2	S3	S6	S10	S12
			—	—	—	—

Feeders

Table 4- 8 Function - Feeders - pre-assembled load feeders



Size						
S00	S0	S2	S3	S6	S10	S12
			—	—	—	—

Table 4- 9 Function - feeders - compact starters





Size	
S00	S0
	

Table 4- 10 Function modules

Components	Size						
	S00	S0	S2	S3	S6	S10	S12
Function modules for mounting on contactors					—	—	—
Function modules for connection to the automation level	 				—	—	—

4.2 Manuals - SIRIUS Modular System

This system manual focuses on the product descriptions of the SIRIUS components in sizes S00 to S12 for motors in the performance range up to 250 kW (400 V). Products which have separate, device-specific manuals, are only briefly mentioned in this system manual. Comprehensive technical details for such devices can be found in the relevant device-specific manuals. You can download the manuals from the Internet (<https://support.industry.siemens.com/cs/ww/en>).

Information about ...	Is available in ...
<ul style="list-style-type: none"> SIRIUS - system overview 	<ul style="list-style-type: none"> "SIRIUS - System Overview" (http://support.automation.siemens.com/WW/view/en/60311318) manual (Article number: 3ZX1012-0RA01-5AC1)
<ul style="list-style-type: none"> 3RT, 3RH and 3RA contactors and contactor assemblies 	<ul style="list-style-type: none"> "SIRIUS - SIRIUS 3RT contactors and contactor assemblies" (http://support.automation.siemens.com/WW/view/en/60306557) manual (Article number: 3ZX1012-0RT20-5AB1)
<ul style="list-style-type: none"> 3RF34 solid-state switching devices 	<ul style="list-style-type: none"> "SIRIUS - SIRIUS 3RF34 solid-state switching devices" (http://support.automation.siemens.com/WW/view/en/60298187) manual (Article number: 3ZX1012-0RF34-5AC1)
<ul style="list-style-type: none"> 3RW soft starters 	<ul style="list-style-type: none"> "SIRIUS 3RW30/3RW40 soft starters" (http://support.automation.siemens.com/WW/view/en/38752095) manual (Article number: 3ZX1012-0RW30-1AC1) "SIRIUS 3RW44 Soft Starter" (http://support.automation.siemens.com/WW/view/en/21772518) manual (Article number: 3ZX1012-0RW30-1AC1)
<ul style="list-style-type: none"> 3RV motor starter protectors 	<ul style="list-style-type: none"> "SIRIUS - SIRIUS 3RV" motor starter protectors (http://support.automation.siemens.com/WW/view/en/60279172) manual (Article number: 3ZX1012-0RV20-5AC1)
<ul style="list-style-type: none"> 3RU, 3RB overload relays 	<ul style="list-style-type: none"> "SIRIUS - SIRIUS 3RU thermal overload relays / SIRIUS 3RB electronic overload relays" (http://support.automation.siemens.com/WW/view/en/60298164) (Article number: 3ZX1012-0RU20-5AC1)
<ul style="list-style-type: none"> 3RB24 electronic overload relays 	<ul style="list-style-type: none"> "3RB24 electronic overload relay for IO-Link" (http://support.automation.siemens.com/WW/view/en/46165627) manual (Article number: 3ZX1012-0RB24-0AC0)
<ul style="list-style-type: none"> 3UG4 monitoring relays / 3RR2 current monitoring relays 	<ul style="list-style-type: none"> "3UG4/3RR2 monitoring relays" manual (http://support.automation.siemens.com/WW/view/en/70210263) (Article number: 3ZX1012-0UG40-0AC0)

Information about ...	Is available in ...
<ul style="list-style-type: none"> 3RS1/3RS2 temperature monitoring relays 	<ul style="list-style-type: none"> "3RS1/3RS2 temperature monitoring relays" manual (http://support.automation.siemens.com/WW/view/en/54999309) (Article number: 3ZX1012-0RS10-1AC1)
<ul style="list-style-type: none"> 3UG48 monitoring relays / 3RR24 current monitoring relays for IO-Link 	<ul style="list-style-type: none"> "3UG48/3RR24 monitoring relays for IO-Link" (http://support.automation.siemens.com/WW/view/en/54375430) manual (Article number: 3ZX1012-0UG48-0AC1)
<ul style="list-style-type: none"> 3RS14/3RS15 temperature monitoring relays for IO-Link 	<ul style="list-style-type: none"> "3RS14/3RS15 temperature monitoring relays for IO-Link" (http://support.automation.siemens.com/WW/view/en/54375463) manual (Article number: 3ZX1012-0RS14-0AC0)
<ul style="list-style-type: none"> 3RA load feeders 	<ul style="list-style-type: none"> "SIRIUS - SIRIUS 3RA load feeders" manual (http://support.automation.siemens.com/WW/view/en/60284351) (Article number: 3ZX1012-0RA21-5AC1)
<ul style="list-style-type: none"> 3RA6 compact starters 	<ul style="list-style-type: none"> "SIRIUS 3RA6 compact starter" (http://support.automation.siemens.com/WW/view/en/27865747) manual (Article number: 3RA6992-0A)
<ul style="list-style-type: none"> 3RA28 function modules for mounting on contactors 	<ul style="list-style-type: none"> "SIRIUS Innovations - SIRIUS 3RA28 function modules for mounting on 3RT2 contactors" manual (http://support.automation.siemens.com/WW/view/en/60279150) (Article number: 3ZX1012-0RA28-5AC1)
<ul style="list-style-type: none"> 3RA27 function modules for connection to the higher level control 	<ul style="list-style-type: none"> "SIRIUS - SIRIUS 3RA2712 function modules for AS-Interface" manual (http://support.automation.siemens.com/WW/view/en/39318922) (Article number: 3ZX1012-0RA27-0AC0) "SIRIUS - SIRIUS 3RA2711 function modules for IO-Link" manual (http://support.automation.siemens.com/WW/view/en/39319600) (Article number: 3ZX1012-0RA27-1AC1)
<ul style="list-style-type: none"> 4SI SIRIUS electronic module (3RK1005-0LB00-0AA0)" 	<ul style="list-style-type: none"> "4SI SIRIUS Electronic Module (3RK1005-0LB00-0AA0)" (http://support.automation.siemens.com/WW/view/en/37856470) manual (Article number: 3ZX1012-0LB00-0AA1)

System properties

5.1 System properties

The entire device spectrum in the SIRIUS modular system is subdivided into the following sizes:

- Size S00: up to 7.5 kW at 400 V
- Size S0: up to 18.5 kW at 400 V
- Size S2: up to 37 kW at 400 V
- Size S3: up to 55 kW at 400 V
- Size S6: up to 90 kW at 400 V
- Size S10: up to 160 kW at 400 V
- Size S12: up to 250 kW at 400 V

The device portfolio has a uniform range of accessories.

5.2 Modular system design

The individual SIRIUS components are modules from the complete SIRIUS modular system (up to size S12, 250 kW at 400 V), which are matched to one another in terms of their size and their technical data. This enables individual requirements to be met quickly and cost-effectively. And it goes without saying that this applies to the uniform range of accessories as well.

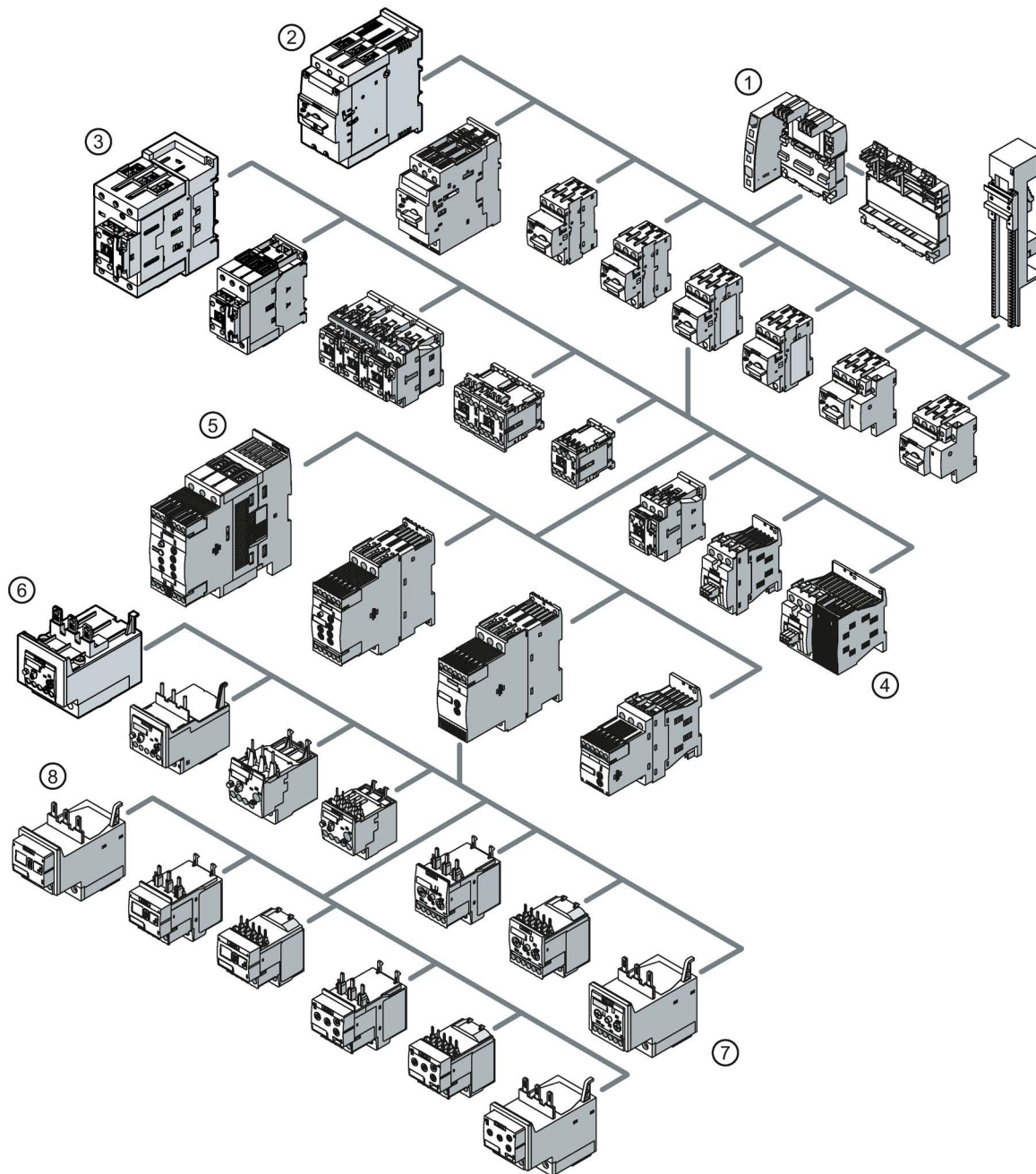

- 1 3RV29 infeed systems and busbar adapters
- 2 3RV2 motor starter protectors

- 3 3RT2 contactors and contactor assemblies
- 4 3RF34 solid-state switching devices
- 5 3RW30/3RW40 soft starters
- 6 3RU2 thermal overload relays
- 7 3RB3 electronic overload relays
- 8 3RR2 current monitoring relays

Figure 5-1 Overview diagram

5.3 Switching technology

The SIRIUS modular system has the right technology for every application:

Table 5-1 Motor starting options

Switching principle	Switching function	SIRIUS products
Electromechanical starting	• Direct-on-line start	• 3RT contactors, 3RA load feeders, or 3RA6 compact starters
	• Reversing start	• 3RA reversing contactor assemblies or 3RA reversing starters • 3RA6 compact starters
	• Star-delta (wye-delta) start	• 3RA contactor assemblies for star-delta (wye-delta) start
Electronic starting	• Direct-on-line start	• 3RF solid-state switching devices
	• Reversing start	• 3RF solid-state switching devices
	• Soft start	• 3RW soft starters

Example: 3RT contactors

3RT contactors can be used for all standard applications up to 250 kW.

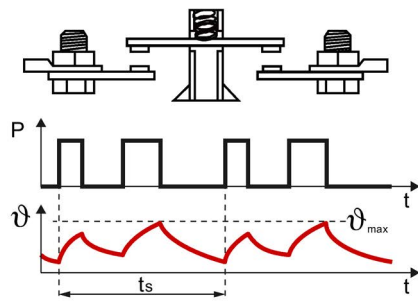

Figure 5-2 Direct switching through current feed of the contactor coil

Example: 3RF solid-state switching devices

3RF solid-state switching devices can be used for frequent switching of motors in parcel distribution systems, for example.

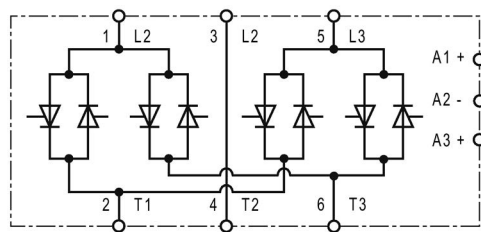

Figure 5-3 Two-phase switching through antiparallel thyristor pairs

Example: 3RW soft starters

3RW soft starters are used for soft starting and ramp-down, for pumps and fans, for example.

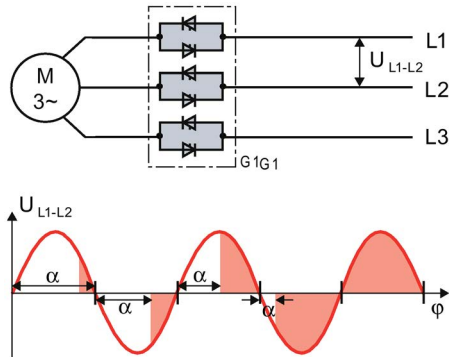



Figure 5-4 Phase angle control of the thyristor pairs

5.3 Switching technology

Technology selection depends on various factors. The table below provides an overview of the most important aspects:

Table 5-2 Technology selection

	Technology		
	Electromechanical	Electronic	
	3RT contactors, 3RA load feeders, or 3RA6 compact starters	3RF solid-state switching devices	3RW soft starters
			
Number of starts per hour	Average	High	Low
Switching service life	Average	Long	Average
Switching capacity	High	Low	High
Occurrence of current peaks	High	High	Low
Occurrence of torque peaks	High	High	Low
Reversing operation	Yes	Yes	No
Acoustic noise generation	Average	None	Low
Galvanic isolation	Yes	No	No
Shock and vibration resistance	Average	High	Average
Power loss	Low	High	Low

5.4 Uniform connection system

The devices are matched to one another in terms of their rated sizes and technical data.



- The same width guarantees quick mounting.
- Devices with the same rated current have the same terminals.
- Device combinations are matched to one another and offer screw-type, spring-loaded, and ring cable lug connection systems. Larger devices are also available with through-hole technology featuring straight-through transformers, bus connection and ring cable lug connection system.

The SIRIUS modular system has the right connection system for every environment.

5.5 Flexible assembly methods

The SIRIUS modular system offers maximum flexibility in terms of configuration. The system components can be assembled as feeders or mounted separately.

Table 5- 3 Assembly (mounted separately or assembled as feeders)

Separately mounted	Mounted as complete feeders
	
<p>The system components are assembled separately (e.g. on separate DIN rails).</p>	<p>The system components are assembled as a unit (e.g. with a link module).</p>

The SIRIUS modular system offers the right solution for every type of assembly:

Table 5- 4 Assembly types

Assembly type	Benefit
<p>Feeders assembled from individual SIRIUS devices</p>	<p>More than 45000 tested combinations offer solutions for almost every application.</p>
<p>SIRIUS 3RA2 load feeders</p>	<p>More than 500 pre-assembled combinations facilitate rapid and fault-free control cabinet assembly.</p>
<p>SIRIUS 3RA6 compact starters</p>	<p>Compact devices with high integrated functionality for improved efficiency and reliability in the control cabinet.</p>

5.6 Performance capability

All components in the SIRIUS modular system can be mounted side by side and operated at an ambient operating temperature of -25 °C to +60 °C. The SIRIUS modular system is optimally suited for applications in demanding environments (in terms of dust exposure, vibration and shock load, etc.). Extensive approvals and certification enable worldwide use.

The table below provides an overview of the individual sizes and performance ranges. A short-circuit breaking capacity of up to 150 kA is available.

Size	SIRIUS products	Current	Power
S00 (45 mm)	3RV motor starter protectors	16 A	7.5 kW
S0 (45 mm)	3RT contactors	40 A	18.5 kW
S2 (55 mm)	3RB electronic overload relays 3RU thermal overload relays 3RR current monitoring relays 3RA load feeders 3RF solid-state relays	80 A	37 kW
S3 (70 mm)	3RV motor starter protectors	100 A	55 kW
	3RT contactors	110 A	
	3RB electronic overload relays	115 A	
	3RU thermal overload relays	100 A	
S6 (120 mm)	Tested assemblies (with 3VA and 3VL molded case circuit breakers) 3RT contactors 3RB overload relays	200 A	90 kW
S10 (145 mm)		300 A	160 kW
S12 (160 mm)		630 A	250 kW

5.7 Assembly and mounting

Accessories such as auxiliary switches and surge suppressors can be mounted quickly and disassembled in just a few short steps. Standard tools are required to disassemble components only very rarely. For the SIRIUS devices with spring-loaded connections, Siemens offers a standardized operating tool (screwdriver 3RA2908-1A).

5.8 Load feeders

Link modules based on screw-type and spring-loaded connection systems are available for assembling device combinations and fuseless load feeders. The link modules establish the mechanical and electrical connections for the devices. Motor starter protectors can be combined with the following devices via link modules:

- Contactors
- Soft starters
- Solid-state switching devices

The SIRIUS devices with spring-loaded terminals, a "plug-in connection system" is available for assembling load feeders. Contactors, solid-state switching devices, and soft starters can be connected to the motor starter protector by simply plugging them in via a link module:

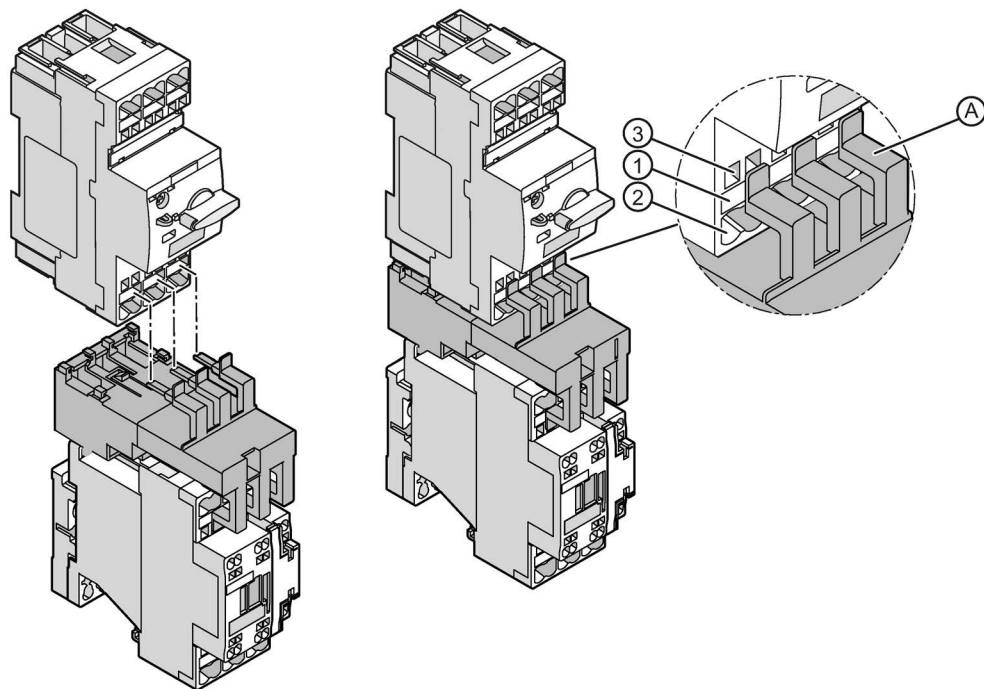

- A Link module
 ① Slot for link modules
 ② Slot for conductor connection
 ③ Screwdriver opening for assembly/disassembly without a link module

Figure 5-5 Link module

The link module is first attached to the device to be connected, then the resulting unit is plugged on to the motor starter protector. This ensures that the requisite electrical and mechanical connections are established in the main circuit.

Overload relays and current monitoring relays can easily be mounted on contactors in a similar way, without the need for another link module:

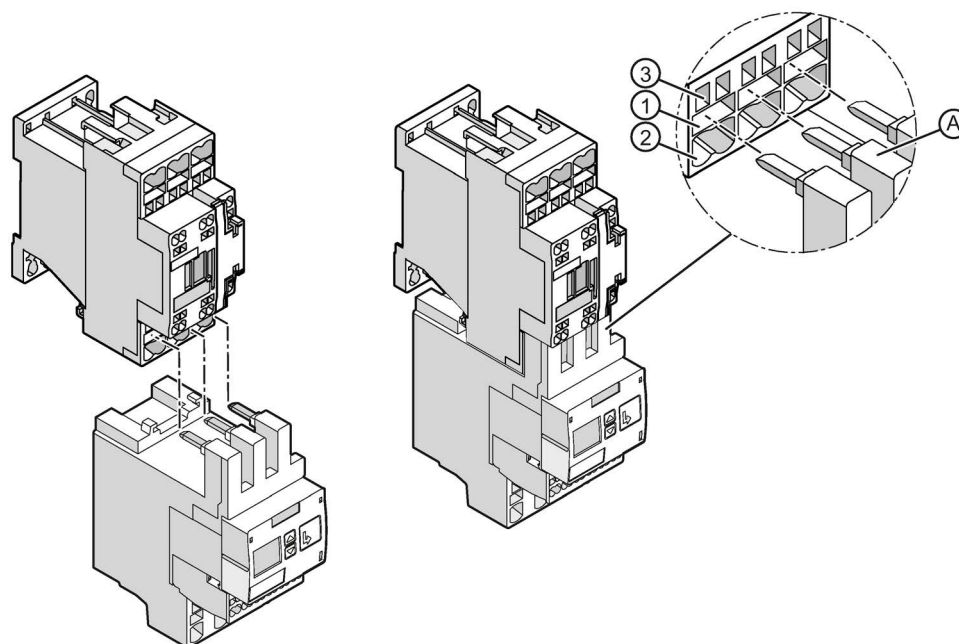

- A Current monitoring relay
- ① Slot for link modules
- ② Slot for conductor connection
- ③ Screwdriver opening for assembly/disassembly without a link module

Figure 5-6 Plug-in connection system on the current monitoring relay

5.9 Application monitoring

The current monitoring relays, which enable intelligent protective functions to be easily implemented within the application, are a central component of the components in the SIRIUS modular system.

Increasing numbers of customers require application monitoring in addition to motor protection. Overload protection (based on I^2t measuring/calculation) provides information on the motorized load, but it does not necessarily allow for conclusions to be drawn regarding the correct execution of processes within the machine. 2- or 3-phase current monitoring with SIRIUS 3RR2 current monitoring relays facilitates the direct monitoring and protection of the application.

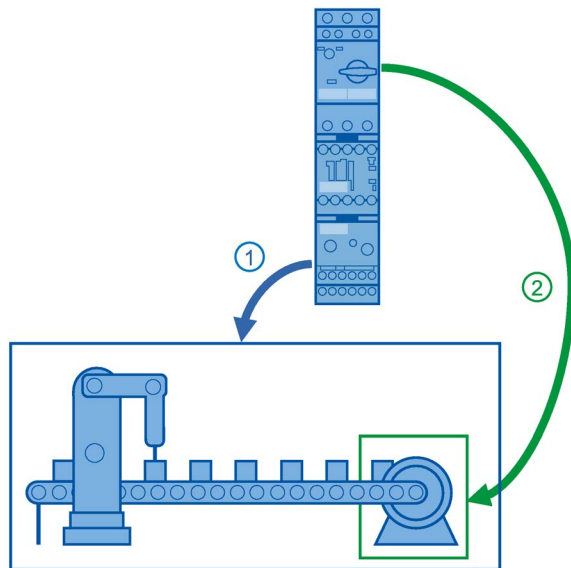

- ① Application monitoring
- ② Motor protection

Figure 5-7 Application monitoring

5.10 Industrial communication

5.10.1 Communication overview

Industrial communication with Siemens products and systems enhances efficiency. Consistent, powerful data networks that will also do justice to future requirements can be realized with components based on proven communication standards, for example IO-Link and AS-Interface. Fast installation and simple connection of sensors and actuators by means of standardized cabling produce time savings and minimize errors. Industrial communication is necessary to record and transmit all measured values, diagnostics data, energy data and product data to control, monitor and protect machinery and production lines.

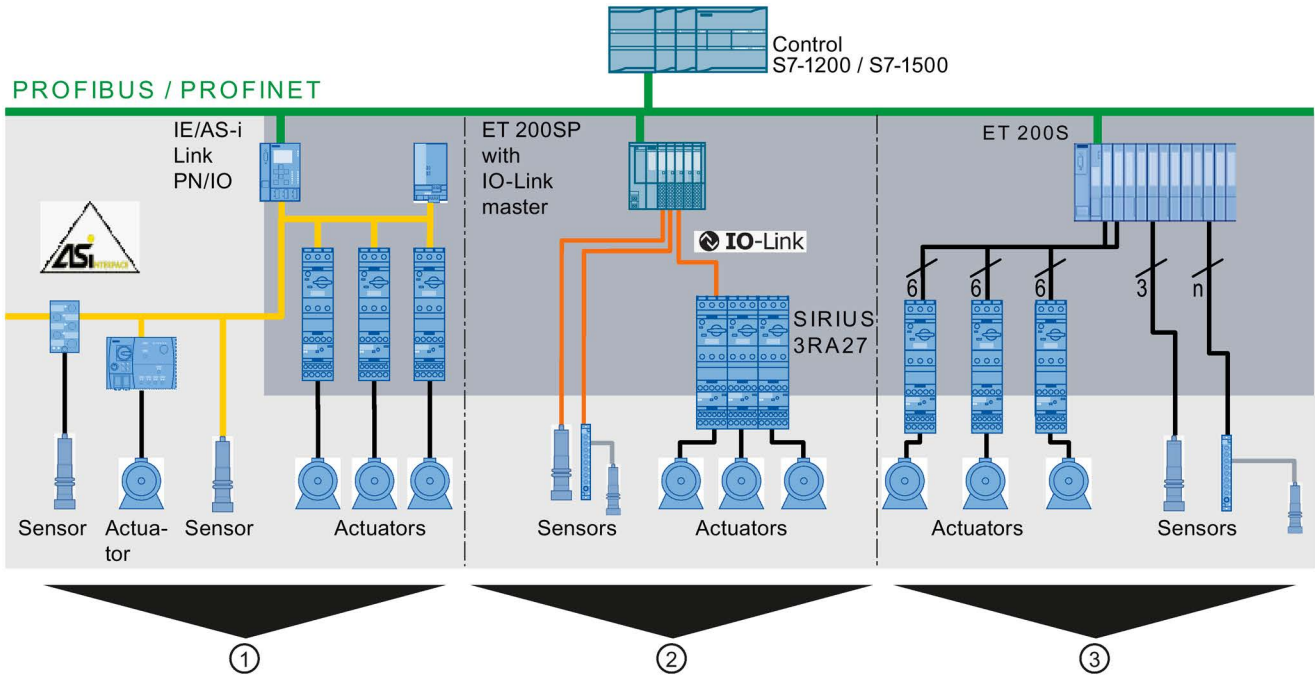

- 1 Acquisition or connection of distributed I/Os and distributed load feeders.
- 2 A point-to-point connection is established via IO-Link if a number of signals are grouped together.
- 3 Classic wiring via digital I/Os is used if the number of signals is manageable.

Figure 5-8 Options for connection to the automation level

IO-Link closes the communication gap at the lowest field level with the sensors and actuators. Moreover, the communication standard reduces the diversity of existing interfaces (e.g. the serial RS-232 and RS-422 interfaces or the standard 4-20 mA signal, etc.) and is based on a conventional point-to-point connection via a standard unshielded three-wire cable. Furthermore, IO-Link is already integrated in the sensor /actuator.

The IO-Link communication standard underneath the control level enables central fault diagnostics and fault locating down to the actuator/ sensor level. Thanks to dynamic modification of parameter data directly from the application, the IO-Link communication standard facilitates commissioning and maintenance. The increasing intelligence of field devices and their integration into automation as a whole now allows data to be accessed right down to the lowest field level. This results in greater plant availability and less engineering work.

With the AS-Interface communication standard, connection of all sensors and actuators in the field to the higher-level control system can be realized more simply, flexibly and efficiently than any other. Via a simple two-wire cable, in an AS-Interface network up to 62 bus nodes can be connected to the AS-Interface master and simultaneously supplied with power.

Connection to the automation level

SIRIUS switching devices can be connected to higher-level control systems using conventional wiring, but also by means of a point-to-point connection (IO-Link) or via a fieldbus (AS-Interface).

The SIRIUS 3RA2711 function modules for IO-Link and the SIRIUS 3RA2712 function modules for AS-Interface enable the assembly of starters and contactor assemblies for direct-on-line, reversing and star-delta (wye-delta) starting without any additional, complicated wiring of the individual components. The devices include the key control functions required for the particular feeder.

The SIRIUS switching devices for AS-Interface and IO-Link are connected to the control system level without any additional wiring. These interfaces ensure that information about the switch position and the readiness of the feeder for operation is transferred, and that contactor control is implemented. In addition to these three items of information relating to feeders, IO-Link also transfers diagnostics data.

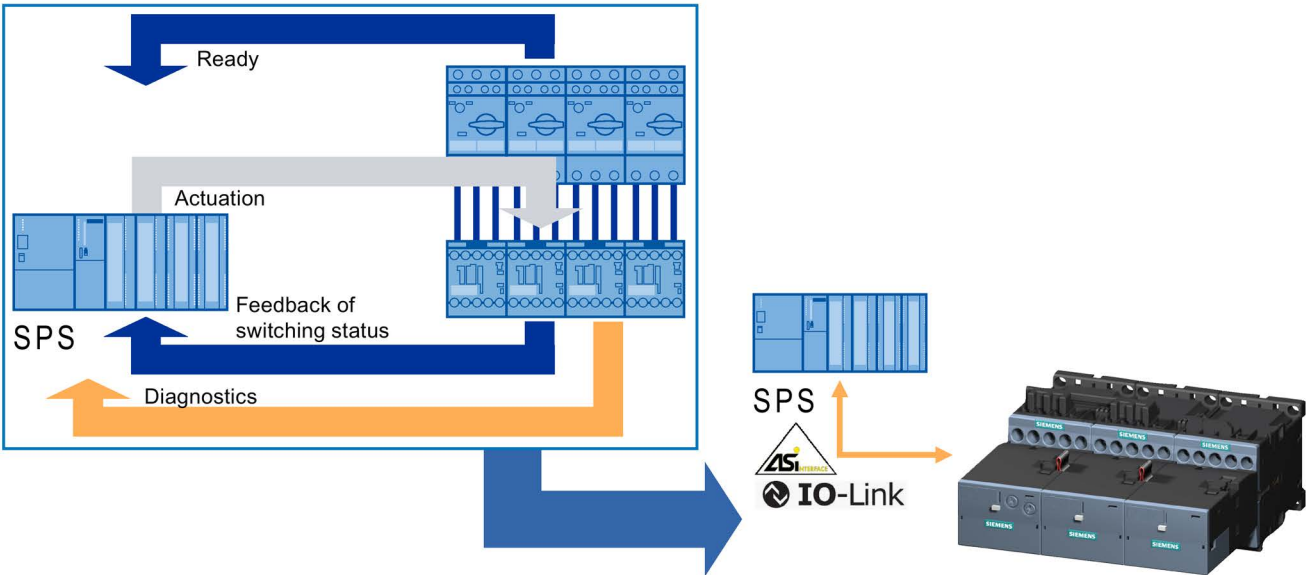

Figure 5-9 Communication via AS-Interface or IO-Link

The SIRIUS 3RA27 function modules or the SIRIUS 3RA6 compact starters can communicate with a higher-level control either via the AS-Interface fieldbus or via the IO-Link point-to-point connection. Cyclic data transmission (DIs and DQs) is identical for both IO-Link and AS-Interface.

Table 5- 5 Motor starter profile

Standard motor starter profile		Group diagnostics (only with IO-Link)
<ul style="list-style-type: none"> • 4 DIs, 2 DQs (per feeder) • 2 LEDs for "Device" and "Group fault" 		<ul style="list-style-type: none"> • Device fault • No main voltage (motor starter protector tripped) • Auxiliary voltage 24 V DC (U_{aux}) missing • Signaling limit position right/left • Manual/local mode
DI 0.0	Ready	
DI 0.1	Motor ON	
DI 0.2	Group fault	
DI 0.3	Group warning	
DQ 0.0	Motor ON or Motor CW	
DQ 0.1	Motor CCW	

5.10.2 IO-Link

5.10.2.1 Overview

IO-Link is a communication standard for sensors and actuators – defined by the PROFIBUS User Organization (PNO). IO-Link technology is based on the point-to-point connection of sensors and actuators to the control system. Therefore, this technology is not a bus system, but an enhanced version of a classical point-to-point connection. In addition to the cyclic operating data, comprehensive parameters and diagnostics data are transferred for the connected sensors and actuators. The same 3-wire connecting cable as currently used for standard sensors is used.

The IO-link system offers important benefits when connecting complex (intelligent) sensors/actuators:

- Open standard in accordance with IEC 61131-9 for transmission of device-specific data
- Simple, standardized and unshielded wiring (also for analog signals) and clearly reduced diversity of interfaces at the sensors /actuators
- Consistent communication between sensor/actuator and the control system
- Consistent diagnostic information right down to the sensor/actuator level
- Alarms and indicators for preventive maintenance
- Dynamic modification of sensor/actuator parameters by the control system or the operator on the HMI
- Reparameterization during ongoing operation
- Consistent device identification

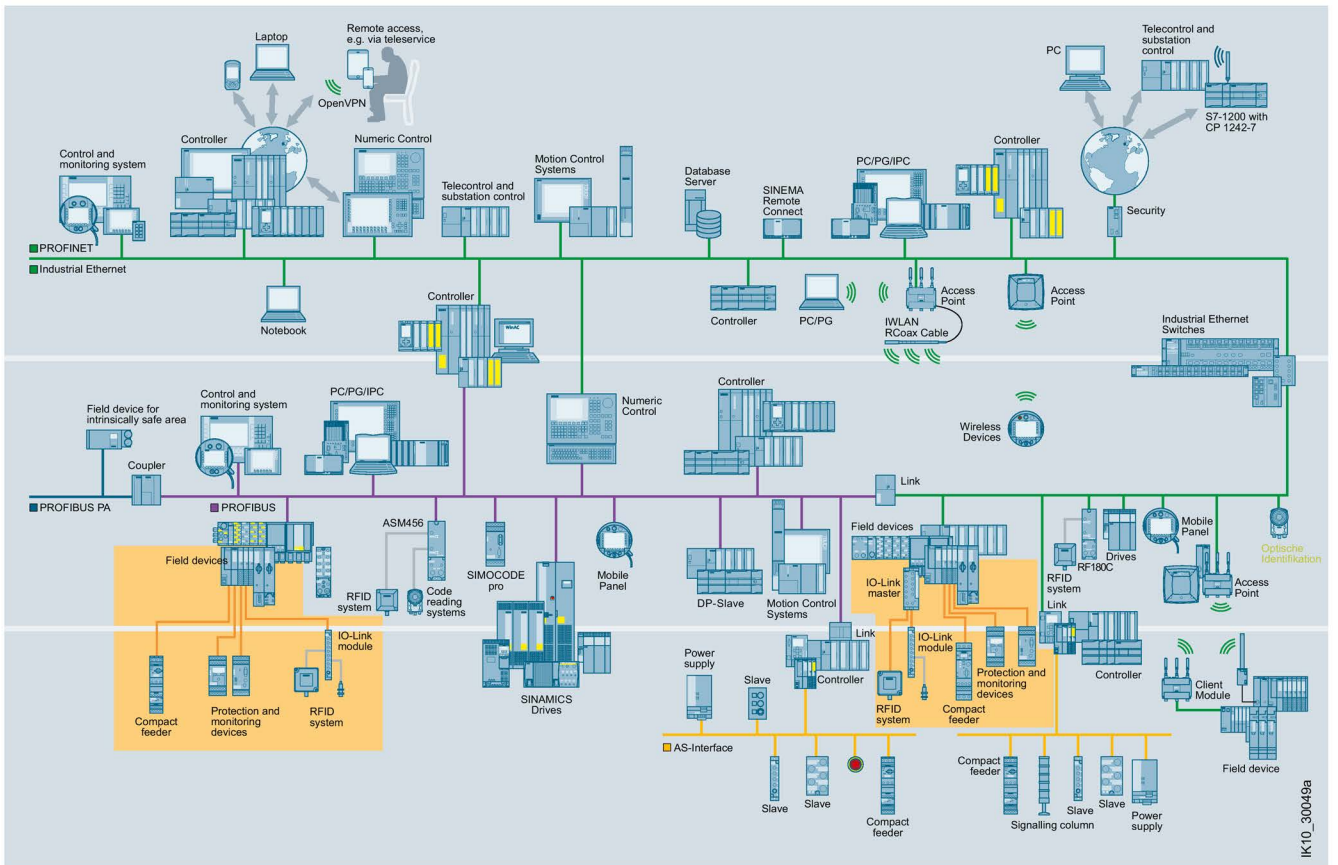

Figure 5-10 IO-Link

5.10.2.2 System components

An IO-Link system essentially comprises the following components:

- IO-Link master
Gateway between the IO-Link device and the higher-level communication system, such as Ethernet-based systems (PROFINET, Ethernet / IP, etc.), fieldbus (PROFIBUS), or a device-specific backplane bus.
- IO-Link device
 - Sensors
 - Switching devices such as the 3RA2711 function module for IO-Link and 3RA64 / 3RA65 compact starters for IO-Link
 - 3RB24 electronic overload relays for IO-Link
 - Monitoring relays for precise monitoring and transmission of electrical and mechanical quantities such as voltage, power factor, speed, fault current, 3UG48 line monitoring, 3RR24 current and 3RS14 / 3RS15 temperature
 - Valve terminal
 - RFID device
 - Indicator light
 - 3SU14 electronic module for IO-Link for connecting SIRIUS ACT 3SU1 pushbuttons and indicator lights
 - 3SU14 electronic module for ID key-operated switches (SIRIUS ACT) for selection of authorization levels and as an access system for groups or individuals
 - etc.
- 3-wire
Unshielded standard cable
- Engineering software and device description files

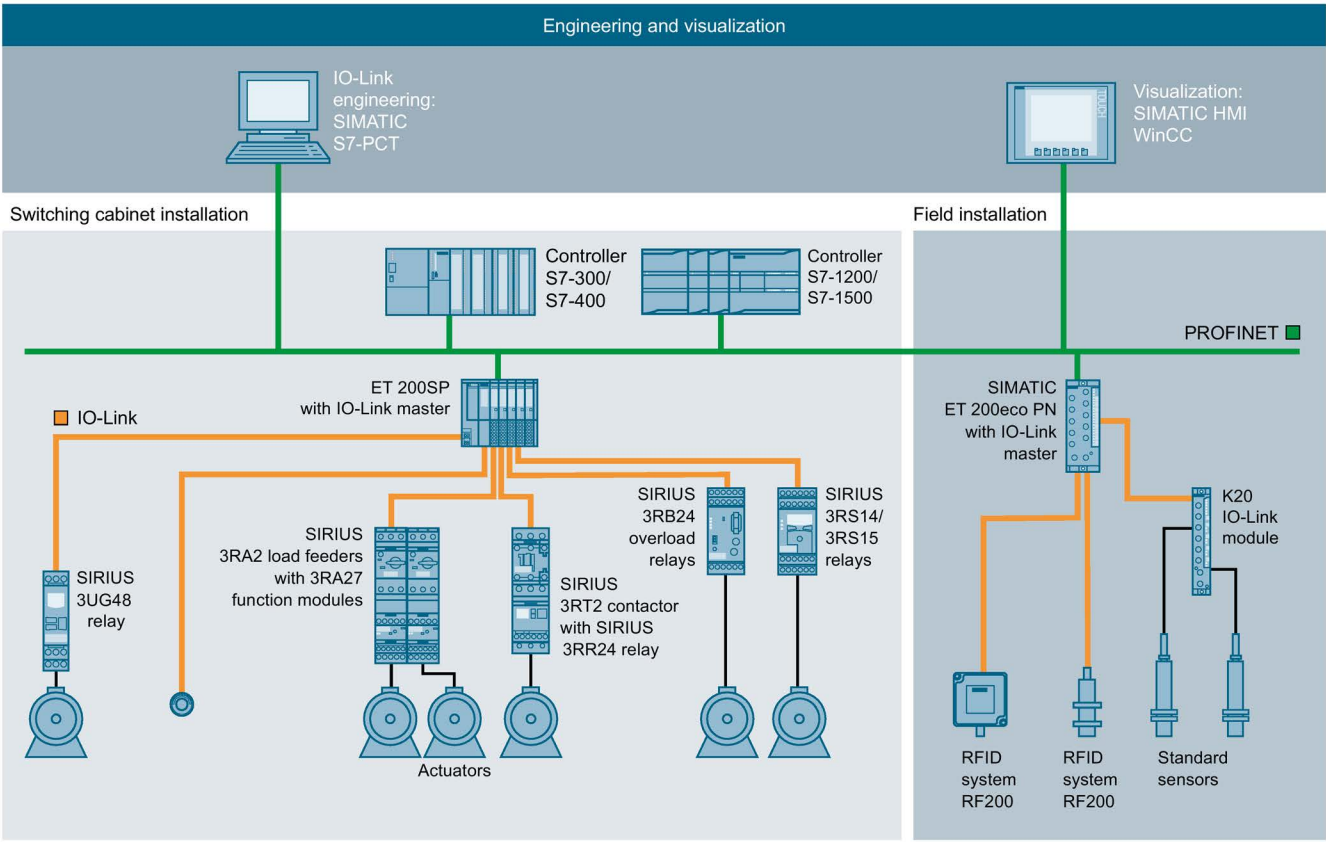

Figure 5-11 Example of a configuration with the system components

Compatibility of IO-Link

IO-Link guarantees compatibility between standard modules and those with IO-Link capability as follows:

- IO-Link sensors/actuators can generally be operated on IO-Link modules (master) and on standard I/O modules.
- Both IO-Link sensors/actuators and current standard sensors/actuators can be used on IO-Link modules (master).
- If conventional components are used in the IO-Link system, naturally only the standard functions are available in this case.
- A large number of IO-Link-capable Siemens components are available for a broad spectrum of applications (e.g. 3RA27 function modules for IO-Link for sizes S00 to S3 for easy fitting onto SIRIUS 3RT2 contactors). These devices also enable a clear reduction of wiring and extensive individual diagnostics, and possess the essential control functions.

Expansion by means of IO-Link input modules (IO-Link module K20)

The compatibility of IO-Link means that you can connect standard (conventional) sensors/actuators to it too. This is particularly effective with the IO-Link input modules, which allow several sensors to be connected at one time via a cable to the controller.

Integration in STEP 7 (STEP 7 V5.5 or higher and STEP 7 TIA Portal V13 SP1 or higher)

Integration of the device configuration into the STEP 7 environment ensures:

- Simple and fast engineering.
- Consistent data storage.
- Fast location and clearance of faults.

A block library is designed to make it easier for users to connect the IO-Link devices, and to demonstrate use of the library using actual examples. The library provides function blocks and UDTs for all IO-Link devices from the Siemens portfolio. These blocks and UDTs standardize and simplify communication with IO-Link devices. The function blocks have a standardized interface for the individual IO-Link devices. For every read/write job, only the data record specified at the input is read/written. You will find the block library and an application example of how to read and write process data and parameterization data of IO-Link devices on the Internet

(<https://support.industry.siemens.com/cs/ww/en/view/90529409>).

This raises productivity across all phases of the system lifecycle – configuration, commissioning, and operation. With the Siemens IO-Link solution, even sensors and actuators below the control system level are optimally integrated with their complete performance capability in the Totally Integrated Automation (TIA) environment.

IO-Link master modules

The SIMATIC ET 200 distributed I/Os and the SIMATIC S7-1200 automation system integrate fast and easy IO-Link communication with sensors and actuators to the established PROFIBUS and PROFINET fieldbus systems and thus to Totally Integrated Automation (TIA).

A broad spectrum of IO-Link master modules is available for the essential systems:

Automation system/distributed I/O system		IO Link master module
For the control cabinet (IP20)	SIMATIC ET 200SP	CM 4xIO-Link communication module
	SIMATIC ET 200S	4SI IO-Link electronic module 4SI SIRIUS electronic module
	SIMATIC S7-1200	SM 1278 4xIO-Link signal module
For installation in the field (IP67)	SIMATIC ET 200AL	CM 4xIO-Link communication module
	SIMATIC ET 200eco PN	4 IO-L + 8 DI + 4 DQ compact module 4 IO-L compact module
	SIMATIC ET 200pro	EM 4 IO-Link HF electronic module

IO-Link devices

Besides the SIRIUS 3RA6 compact starter, which can be connected simply to the IO-Link master via a standardized IO-Link connection, Siemens offers the SIRIUS 3RA27 function modules for IO-Link for connection to IO-Link. The SIRIUS 3RA27 function modules for IO-Link are plugged directly onto a SIRIUS 3RT2 contactor. As a result, whole groups of load feeders become immediately capable of communicating. Up to four load feeders (direct-on-line starters, reversing starters and star-delta (wye-delta) starters) can be combined in a group, occupying one port on the IO-Link master as one IO-Link device.

Moreover, a large number of monitoring relays and overload relays are available for connecting to IO-Link, thus enabling transmission of various electrical and mechanical quantities and temperature values to the higher-level control system.

K20 IO-Link input modules with versions for 4 or 8 digital inputs are available for connection of binary sensors. The sensors are connected by M8 or M12 connection technology. Connection to the IO-Link master is made using a standard M12 connecting cable. SIRIUS ACT pushbuttons and indicator lights can also be connected to the higher-level control system via IO-Link.

5.10.2.3 Benefits

Benefits

The IO-link system offers important benefits when connecting complex (intelligent) sensors/actuators:

- Dynamic modification of the sensor and actuator parameters directly via the PLC.
- Possibility of device replacement during operation without a programming device/PC, by means of re-parameterization via the consistent storage of parameters.
- Fast commissioning due to central data storage.
- Integrated diagnostics information as far as the sensor and actuator levels.
- Uniform and significantly reduced wiring of different sensors and actuators.
- Fewer parameterization tools.
- Integrated communication: transmission of process data and service data between sensors/actuators and the control.
- Uniform and transparent configuration and programming by means of a parameterization tool (Port Configuration Tool S7-PCT) integrated into SIMATIC STEP 7.
- Transparent representation of all parameter and diagnostics data.
- Reduced costs during configuration and commissioning.
- Diagnostics and measured values for preventive maintenance and energy management.

5.10.2.4 Applications

Applications

IO-Link can be used in the following applications:

- Simple connection of complex sensors/actuators with a large number of parameters to the control.
- Optimum replacement of IO-Link modules for sensor/actuator boxes when connecting binary sensors.

In both cases, all diagnostics data is transmitted to the higher-level control via IO-Link. Parameter settings can be changed during operation. A sensor/actuator can be replaced without a programming device/PC thanks to the central data storage feature.

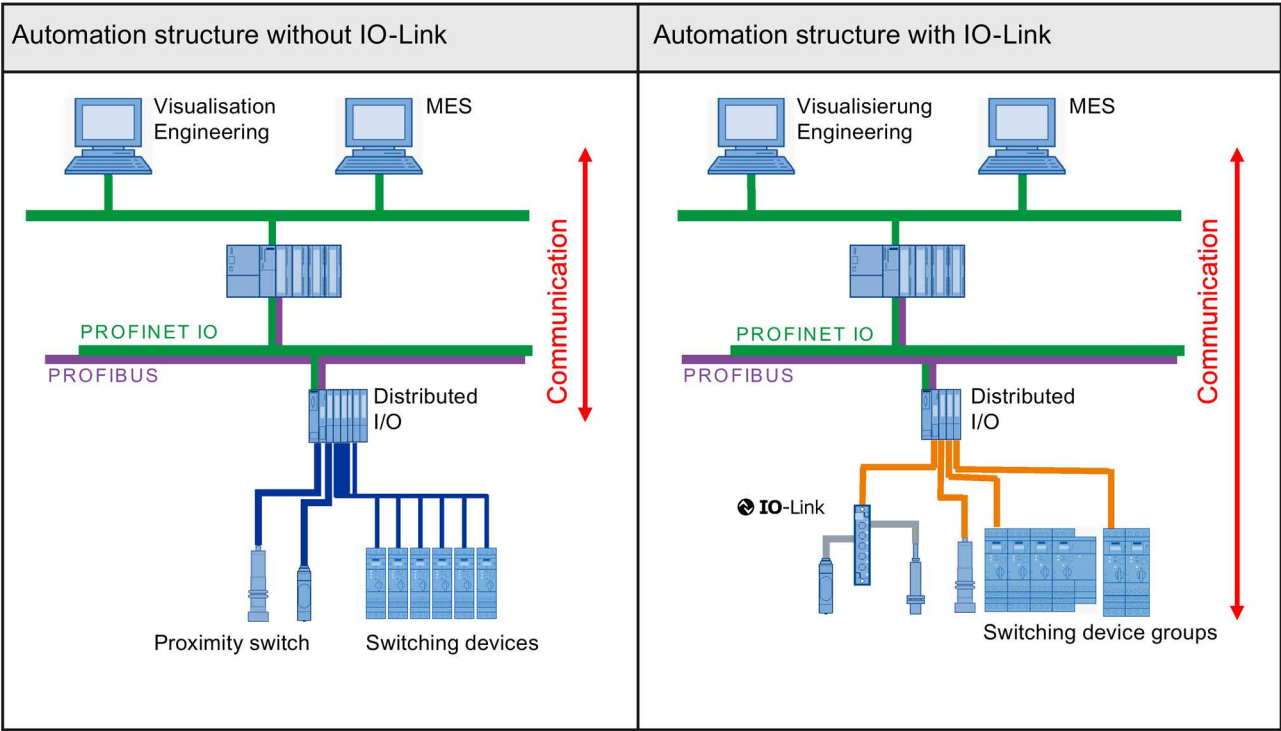

Figure 5-12 Comparison of automation structures with and without IO-Link

5.10.2.5 More information

More information

Always observe the conditions and constraints for use and the additional information available for the modules referred to above.

IO-Link function manual

You will find further information on IO-Link in the IO-Link function manual (<https://support.industry.siemens.com/cs/ww/en/view/65949252>).

Internet

You will find further information on IO-Link on the Internet (<https://support.industry.siemens.com/cs/ww/en/ps/15818>).

You will find an overview of the most important documents and links on IO-Link here (<https://support.industry.siemens.com/cs/ww/en/view/109737170>).

5.10.3 AS-Interface

5.10.3.1 Overview

The AS-Interface is an open, international standard in accordance with EN 50295 and IEC 62026-2 for process communication and field communication. Leading manufacturers of actuators and sensors worldwide support AS-Interface.

AS-Interface is a single master system. For direct integration into automation systems from Siemens, e.g. S7-300 or S7-1200, communications processors (CPs or CMs) are the obvious choice. In addition, AS-i networks can also be connected via PROFINET or PROFIBUS with the help of routers (links).

In both cases, the lower-level AS-i networks with connected actuators and sensors can be parameterized and diagnosed direct from the controller.

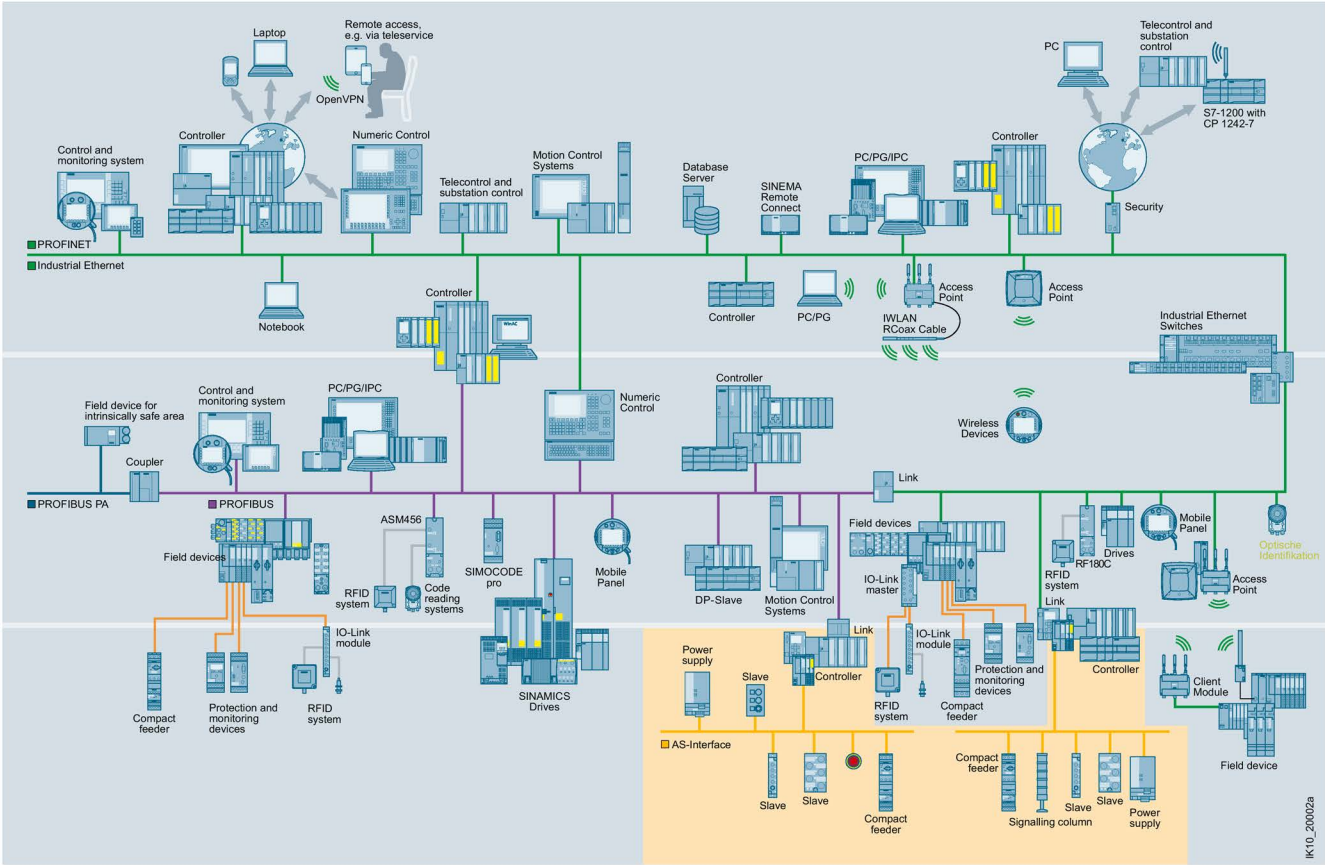

Figure 5-13 AS-Interface

5.10.3.2 System components

Numerous system components are offered to perform communication. The main components of a system installation are:

- Master interface modules for central control units such as SIMATIC S7, ET 200 distributed I/O or network transitions from PROFIBUS/PROFINET to AS-Interface
- AS-Interface shaped cable
- Network components, e.g. repeater and extension plug
- Power supply unit for powering the slaves
- Modules for connecting standard sensors/actuators
- Sensors and actuators with integrated AS-i slave (e.g. motor starters, soft starters, load feeders, pushbuttons, indicator lights, or position switches)
- Secure modules for transferring safety-related data over AS-Interface
- Addressing device for setting slave addresses during commissioning

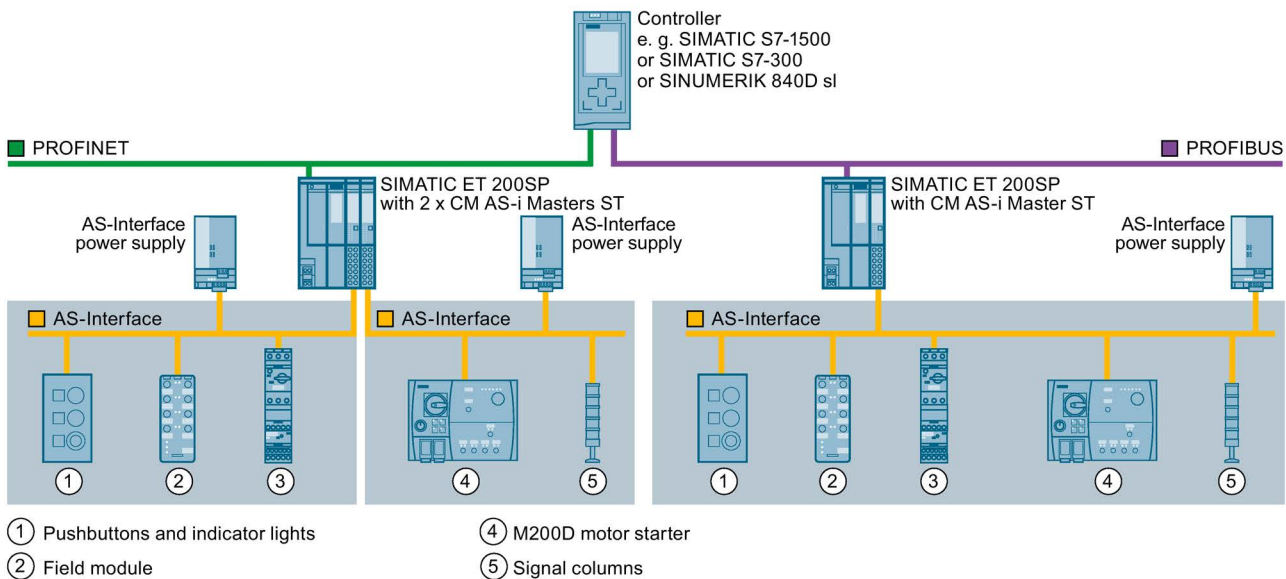

Figure 5-14 Configuration of AS-Interface networks under a SIMATIC ET 200SP

ASIsafe

ASIsafe enables the integration of safety-related components, such as EMERGENCY-STOP pushbuttons, protective door switches or safety light arrays, in an AS-Interface network. The safety-related components are fully compatible with the familiar AS-Interface components (masters, slaves, power supplies, repeaters, etc.) in accordance with IEC 62026-2 and are operated in conjunction with them on the yellow AS-Interface cable. The transmission method for safety-related signals is released for applications up to PL e according to EN ISO 13849-1 and up to SIL 3 (IEC 61508/EN 62061).

Integration in STEP 7

With the integration of AS-Interface into the TIA Portal, users benefit from a highly consistent network view: All network nodes are presented in a clear graphical manner. Handling is identical to that of PROFIBUS and PROFINET networks.

5.10.3.3 Benefits

An important characteristic of the AS-Interface technology is the use of a shared two-wire cable for data transmission and distribution of auxiliary power to the sensors and actuators in a high degree of protection IP65 / IP67. One AS-Interface power supply unit per AS-i network is used to distribute the auxiliary power.

The AS-i network is installed with the help of a profiled (reverse-polarity-protected) AS-Interface cable on which the AS-i slaves can be mounted as desired. The AS-i network is electrically contacted by the piercing contacts of the AS-i slaves (insulation displacement method). Any bus topology can therefore be chosen.

Complex control cable wiring in the control cabinet and terminal blocks can be replaced with AS-Interface. Thanks to a specially developed cable and the insulation displacement method, the AS-Interface cable can be connected anywhere. This concept is extremely flexible and enables you to make huge savings.

AS-Interface has the following advantages:

- Open standard
- Flexible topologies
- Only one cable for data and energy
- Safety functions
- Time-saving mounting and installation
- Engineering in the TIA Portal
- Convenient addressing
- Device and network diagnostics
- Expandability
- Fast device replacement

5.10.3.4 Application

The AS-Interface is used where individual actuators and sensors are distributed at different locations on a machine (e.g. in a bottling plant or production line, etc.). AS-Interface replaces complex cable harnesses and connects binary and analog actuators and sensors such as proximity switches, valves, or indicator lights with a control, such as SIMATIC, or a PC.

In practice this means that the installation process is really simple, because both data and power are transported via the same cable. No expert knowledge is required for installation and commissioning. Furthermore, thanks to the simple cable laying procedure and the clear cable structure, as well as the special design of the cable, you not only significantly reduce the risk of errors, but also service and maintenance costs.

The AS-i master automatically transfers the inputs and outputs between the controller and the digital and analog AS-Interface slaves. Slave diagnostics information is forwarded to the control system when required. The latest AS-Interface masters according to the AS-Interface Specification V3.0 support integrated analog value processing. This means that data exchange with analog AS-Interface slaves is just as easy as with digital slaves.

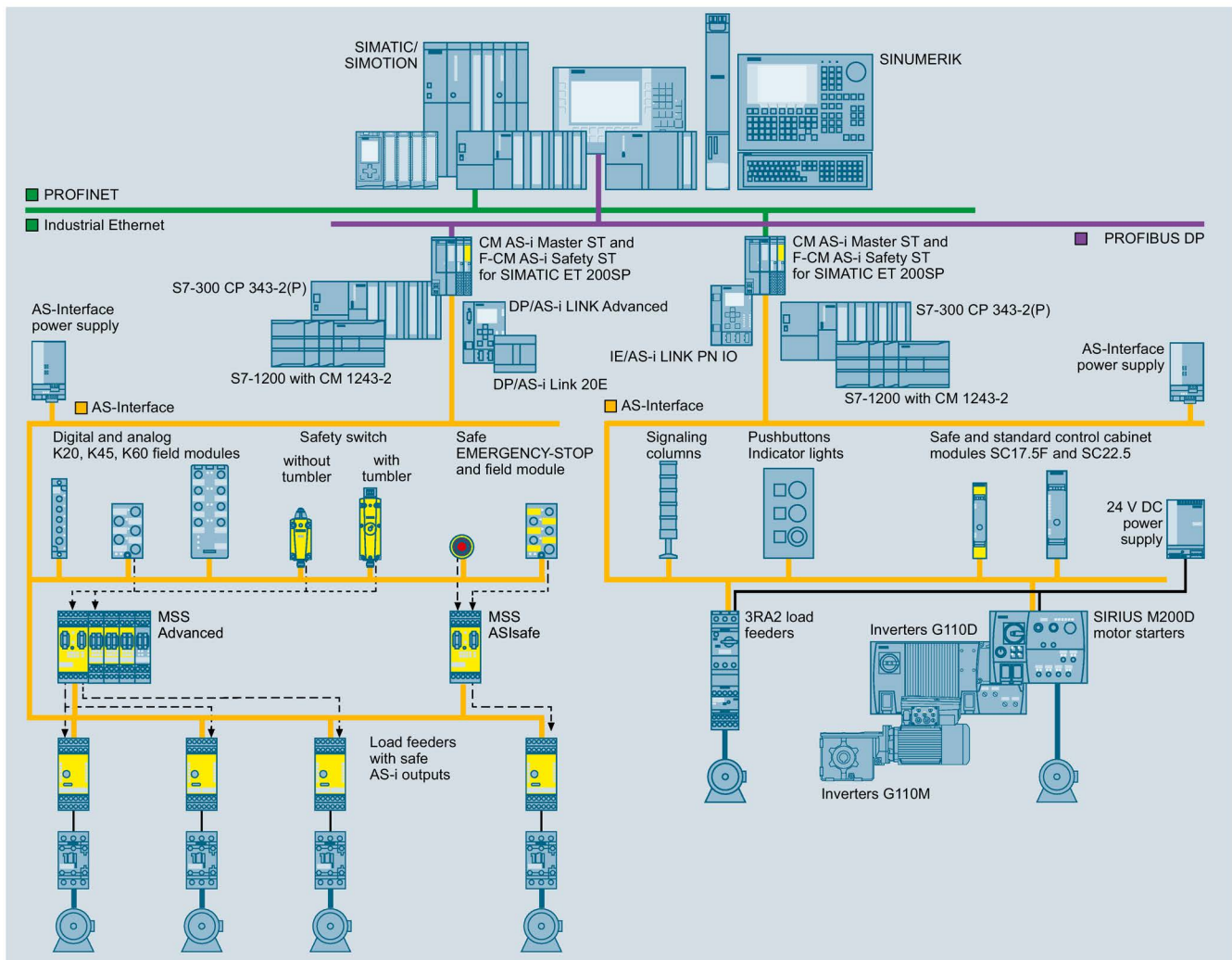

Figure 5-15 Example of a system configuration

5.10.3.5 More information

More information

Always observe the conditions and constraints for use and the additional information available for the modules referred to above.

AS-Interface System Manual

More information about the AS-Interface is available in the AS-Interface System Manual.

The system manual can be downloaded from the Internet
(<http://support.automation.siemens.com/WW/view/en/26250840>) free of charge:

Internet

You will find further information on AS-Interface on the Internet
(<http://support.automation.siemens.com/WW/view/en/10805888/130000>).

5.11 Safety applications

SIRIUS switching devices are often used in parts of the system which have a bearing on safety. The Safety Integrated concept enables uniform solutions to be created, from safety relays through to fail-safe communication via AS-Interface or PROFIBUS DP.

Example

SIRIUS contactor in a safety application:

- Motor starter protectors in combination with undervoltage release and contactor: PL d (ISO 13849-1) or SIL 2 (IEC 62061)
- Contactor assemblies for star-delta (wye-delta) start: PL e (ISO 13849-1) or SIL 3 (IEC 62061)

5.12 Environmental protection

Siemens attaches great importance to the subject of eco-design. Our company-internal standard SN 36350 on environmentally compatible product design has been permanently integrated in our product development processes since 1993. Our production meets the highest quality and environmental standards.

The CO₂ balance is another important topic as regards the manufacturing processes used for our products. All Siemens products are eco-labeled in accordance with DIN EN ISO 14021 as a matter of course. This process of eco-labeling makes our environmentally-compatible product design more transparent and ensures that a continual improvement in the CO₂ balance can be observed.

5.13 Energy efficiency

5.13.1 Energy efficiency

The **SIRIUS modular system** offers products that significantly reduce energy consumption in the control cabinet thanks to their minimum intrinsic power losses. The modular system includes devices that not only switch reliably, but also measure energy and thus supply solutions for energy-optimized drive concepts.

Energy efficiency increases resulting from the use of SIRIUS devices can be divided into three topic areas:

- Acquisition of measured energy values
- Reduction in intrinsic power losses
- Optimal drive solution

These three pillars form the basis of optimized energy management with the support of products from the SIRIUS modular system.

5.13.2 Acquisition of measured energy values

Acquisition of measured energy values (identification of energy flows)

One of the essential starting points for increasing energy efficiency is the acquisition of energy flows through detailed analysis of the machinery and systems used. You can do without installing additional measuring instruments if you use switching devices with integral current acquisition and communication interface at the planning phase, e.g. motor starters of the SIMATIC ET 200S distributed I/O device. These switching devices can transfer the up-to-date current value to the higher-level controller via PROFIBUS or PROFINET. With overload relays for IO-Link, monitoring relays for IO-Link, the SIMOCODE motor protection and control device, or the SIRIUS 3RW44 soft starter, further additional measured values such as voltage and power values can be acquired and transferred. Like the ET 200S motor starter and the High Feature motor starter, the M200D motor starter in degree of protection IP65 offers current values in the standard format of the PROFEnergy profile. This simplifies integration into energy management systems. The measured values of the actuators – thus simultaneously serving as sensors – can be dragged and dropped to the visualization system of the energy data.

Thanks to evaluation and analysis of the measured current values, energy management systems are able to make an assessment of the current situation and thus shut down individual load groups or consumers.

5.13.3 Reduction in intrinsic power losses

Reduction in intrinsic power losses (calculation of potential savings)

Each device installed in a control cabinet produces a power loss. For example, devices with integral power electronics (e.g. soft starters) are already burdened with higher power losses than non-solid-state power contactors. Significantly higher power losses are sustained when using frequency converters.

The power loss can be perceived in the form of heat that usually has to be minimized with high energy consumption using, for example, fans or air conditioners requiring regular maintenance. By using SIRIUS soft starters, the power semiconductors are bypassed after the power-up phase with the help of bypass contacts. This reduces the resulting heat losses to a minimum.

When using **SIRIUS contactors**, the potential savings in the main circuit are extremely low since the electromechanical contacts generate very low intrinsic heat losses. The savings potential is to be found in the control circuit where the pickup currents and holding currents of conventional AC coils or DC coils are reduced by up to 92 % thanks to modern control electronics.

The control electronics of these contactors with electronic operating mechanism (AC / DC drive) offer the following benefits:

- Smaller power supply units in the control circuit thanks to significantly reduced pickup currents and holding currents
- Control optionally with DC voltage or AC voltage
- Reduced stockkeeping thanks to wide voltage ranges
- Control by 0.5 A outputs of the controller
- Avoidance of overvoltage damage in the control electronics thanks to integral suppressor circuit

In the sphere of influence of IEC standards, **fuseless** design of **load feeders** has become established. The preferred method of protecting plants, cables and motors is to use circuit breakers or motor starter protectors with conventional electromechanical design. The protective function against overload is performed with the help of bimetal strips with low heat losses. These losses are reduced by up to 20% on the SIRIUS devices (size S0) thanks to the use of modern materials, so that it has been possible to increase the maximum settable current from 25 A to 40 A.

The current setting ranges of the **SIRIUS motor starter protectors** overlap (size S00: 11 ... 16 A and size S0: 14 ... 20 A). If the user requires, for example, a motor starter protector for a 7.5 kW IE2 motor ($I_N = 14.7$ A), the size S0 motor starter protector is the obvious choice since the intrinsic power losses can be reduced by up to 40% thanks to the low setting of the overload protection.

As well as the widespread use of fuseless load feeders, the following reasons speak in favor of the design with **SIRIUS overload relays (thermal or electronic)**:

- Differentiation of the signals for overload and short-circuit
- Extremely high short-circuit breaking capacity in high rated operating voltage ranges in combination with fuses

Further benefits result from the use of electronic overload relays instead of the widely used thermal overload relays:

- Wide setting range of the rated operational current of up to 1:10
- Adjustable tripping classes (also suitable for heavy starting)
- Remote reset after overload tripping

Thanks to the use of the electronic overload relays and the fact that there is no need for the motor starter protector, power losses are reduced by up to 98%. This reduction in intrinsic heat buildup can significantly simplify air-conditioning in the control cabinet, particularly with compact constructions.

The **SIRIUS compact starter** represents a new class of energy-efficient switching devices. The combination of motor starter protector, contactor and electronic overload relay in one enclosure, and the specified benefits of each individual device result in savings in intrinsic power losses of up to 80% compared to conventional load feeders.

Consistent use of energy-efficient switching devices allow significant reductions in the intrinsic losses of the devices and the associated measures for heat dissipation in the control cabinet. This essential benefit affects not only power costs but also the availability of the plant.

5.13.4 Optimal drive solution

Optimal drive solution (specific measures for realizing potential energy savings)

Three-phase induction motors have a substantial responsibility for the power of a machine. These motors can be operated in the most diverse ways. While the optimal area of application of the frequency converters is in closed-loop speed control, soft starters specialize in the regulation of current and torque during start-up and run-down. In combination with the contactor-based motor starters and load feeders, soft starters have a cost-optimized design for long operating periods at rated speed of the motors.

In such applications, the obvious choice is the combination with motors of Energy Efficiency Class 2 (IE2) or high-efficiency motors of Energy Efficiency Class 3 (IE3). These motors have especially low power losses in operation and thus improve the energy balance.

The power losses of the devices increase as the functionality increases. Choosing an optimal drive solution requires economic dimensioning of the motor power to avoid generating high losses with overdimensioned motors and later having to adapt an overdimensioned application to low requirements using a frequency converter. Simple closed-loop control methods, such as two-step controllers, usually represent an ecologically better and economically more favorable alternative.

Further savings potential, e.g. with pumps, fans or compressors, the obvious choice is a combination of a cascaded frequency converter and switching devices. In this case, the switching devices cover the basic load requirements of the plant, and the frequency converter covers the variable proportion of the application. This means the following benefits of both drive systems can be optimally exploited:

- Very user-friendly closed-loop control
- Low intrinsic energy losses with simultaneously high efficiency

5.13.5 Energy efficiency examples

The devices which make up the SIRIUS modular system are designed for minimum power loss, and passively and actively support the realization of efficient systems and applications.

The devices have an average 10% lower intrinsic power loss so that, as well as saving on energy costs, the heat generated in the control cabinet can also be reduced. This enables a higher packing density in the control cabinet and reduces the cooling capacity.

The following examples show the reduction in intrinsic power loss compared to the predecessor devices.

Product example soft starters

- Reduction of peak loads by up to 60%.
 - The soft starter protects the connected products and systems both on the connection and drive sides.
- Minimum intrinsic power loss thanks to integrated bypasses.
 - The complete soft starter portfolio bridges the thyristors during operation by means of bypasses and thus enables the intrinsic power loss to be reduced to contactor level.
 - 1 W power loss requires 3 W cooling expenditure. Typical frequency converters generate a power loss which is 30 times higher than that created by a comparable soft starter (bypass operation) and thus require 90 times the cooling expenditure.
- The most space-saving starter ever.
 - Volume reduction compared to typical contactor assemblies for star-delta (wye-delta) start: 66 %.
 - Volume reduction compared to typical frequency converters: up to 98%.

Product example contactors

- Minimized holding and closing power.
 - The aspects of low power loss and further optimization of the holding and closing power ratings played an important role in the development of SIRIUS contactors.
 - SIRIUS contactors with electronically controlled coils support further reduction of the holding power by up to 90%.
 - All SIRIUS contactors can be used on the Chinese market, as they meet the Chinese energy efficiency standard GB 21518-2008 for AC contactors in accordance with "Grade 2". The contactors thus far exceed the minimum requirement ("Grade 3") and are optimally equipped for the future.

Product example compact starters

- Only one switching point for minimized losses on the current path.
 - Thanks to the combined functions of an electronic overload relay, a motor starter protector, and a contactor in a single device, transfer resistances (switching points, cable transitions, etc.) are reduced to a minimum.

Product example overload relays

- Electronics instead of bimetal for minimized intrinsic power loss.
 - In addition to a wide setting range of up to 1:10, the application of electronic sensors and actuators facilitates intrinsic power loss reductions of more than 98%.
- Optimized thermal release (bimetal).
 - For devices with thermal overload relay, the power loss compared to predecessor products is reduced by 5 to 10% thanks to the optimized bimetal release.

Customer benefits

6.1 Customer benefits

Customer benefits

SIRIUS offers benefits in the following areas:

- Assembly and handling
- Planning and configuration
- Connecting to higher-level control systems
- Applications at a glance

Table 6- 1 Customer benefits

Area	Technical highlights	Customer benefits
	Proven and optimized modularity and functional diversity in the SIRIUS modular system	Maximum flexibility for application-oriented solutions
	Performance increase with unchanged size, functions which are already integrated, and "all-in-one" solution with compact starters	Space savings in the control cabinet
	Reduced variance, e.g. thanks to size-independent accessories and wide voltage and wide setting ranges	Reduced storage costs as well as planning and ordering expenditure

6.1 Customer benefits

Area	Technical highlights	Customer benefits
<p>Assembly and handling</p>	<ul style="list-style-type: none"> • Load feeders: Easy to implement up to 250 kW / 400 V from standard devices • Modular structure: Everything fits together and can be combined • Versions and sizes: Economical and flexible thanks to 7 compact sizes • Accessories: Low variance with uniform accessories • Design: Fast startup, short setting-up times, and simple wiring • Mounting: Permanently secure mounting, with screw terminals or simply by plugging in • Spring-loaded connection system: Quick and secure connection, vibration-proof and maintenance-free • Reduced wiring: Significant reductions in cable connections thanks to plug-in design and IO-Link or AS-Interface • Assembly of starters with plug-in connection system • Corresponding infeed systems and integrated functionalities 	<p>Reduced wiring expenditure and fault avoidance in terms of assembly and handling</p>
<p>Applications at a glance System monitoring</p>	<ul style="list-style-type: none"> • Maintenance: Extremely durable, low maintenance and reliable • Application monitoring: integrated extremely flexibly into the feeder – thanks to monitoring relays and function modules for extremely simple application monitoring • IE3 / IE4ready: With the SIRIUS modular system, we also offer you our familiar reliability when converting to IE3 / IE4 motors • Remaining lifetime detection for 3RA6 compact starter • Comprehensive diagnostics messages 	<p>Increased operational reliability and system availability</p>

Area	Technical highlights	Customer benefits
Connecting to higher-level control systems	<ul style="list-style-type: none"> • Industrial communication: Standardized connection to AS-Interface, IO-Link and PROFIBUS DP possible 	Optimum integration in the automation environment (TIA)
Planning and configuration	<ul style="list-style-type: none"> • Configuration: Easy and fast thanks to extensive CAx data provision • Service: Short delivery times even for spare parts thanks to global logistics network • Environment: Environmentally friendly production and materials, recyclable • Design: Clear-cut, ergonomic design (winner of the iF Product Design Award) • Configurator: For the simplest possible selection of products including accessories • Can be used worldwide: thanks to comprehensive approvals • Numerous combination tests for SIRIUS 	<ul style="list-style-type: none"> • Simplified system planning and documentation • Global applicability

6.1 Customer benefits

SIRIUS offers the perfect solution throughout the entire product lifecycle:

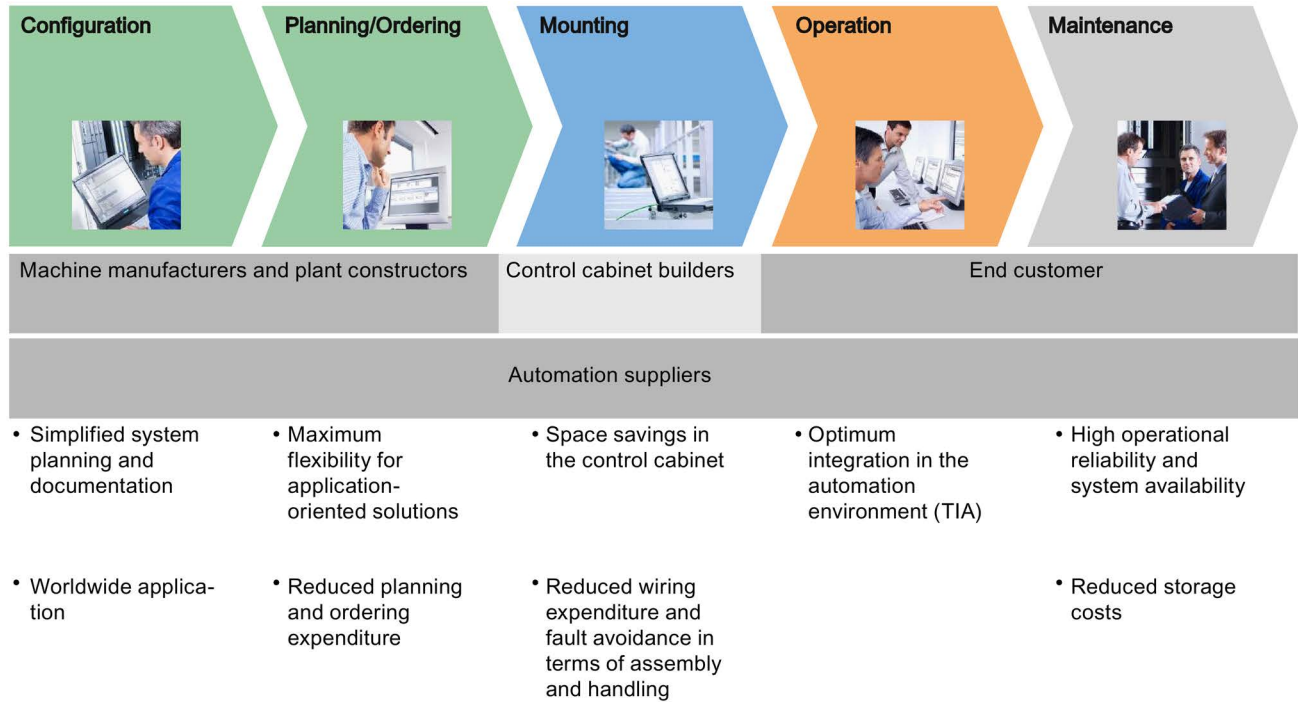

Figure 6-1 Customer benefits by product lifecycle

Components and combinations

7.1 Switching and starting

7.1.1 SIRIUS 3RT contactors

7.1.1.1 Overview of the contactor range

The SIRIUS portfolio offers various switching devices for the safe and functional switching of electrical loads. The table below provides an overview of the contactor versions and contactor assemblies available in sizes S00 to S12 (table contains versions featuring screw-type connection system).

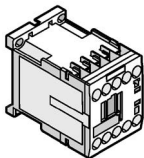
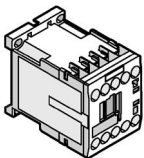
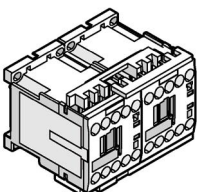
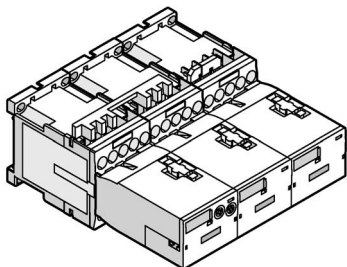
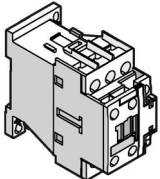
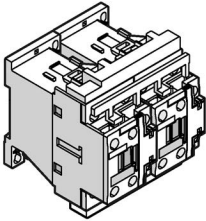
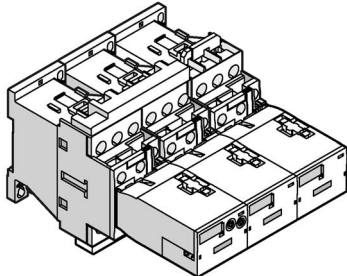
Size	3RH2 contactor relays	3RT2 power contactors	3RA23 reversing contactor assembly	3RA24 contactor assembly for star-delta (wye-delta) start
S00				
S0	---			

7.1 Switching and starting

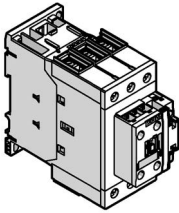
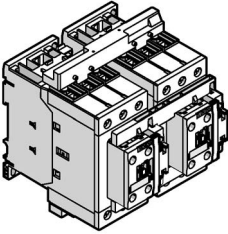
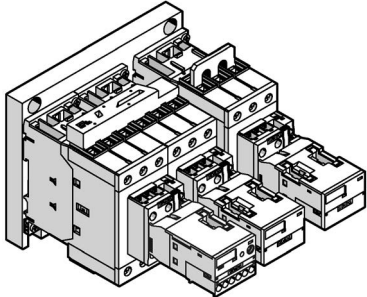
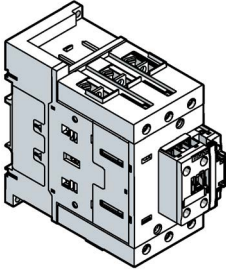
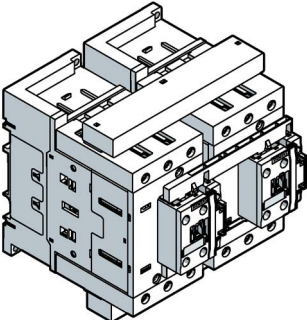
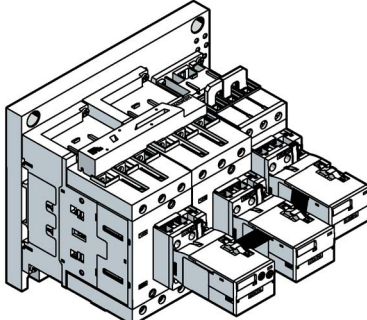
Size	3RH2 contactor relays	3RT2 power contactors	3RA23 reversing contactor assembly	3RA24 contactor assembly for star-delta (wye-delta) start
S2	---			
S3	---			

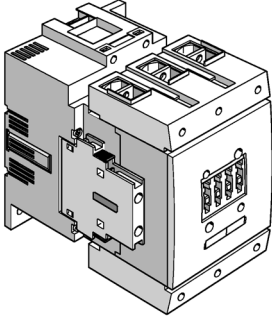
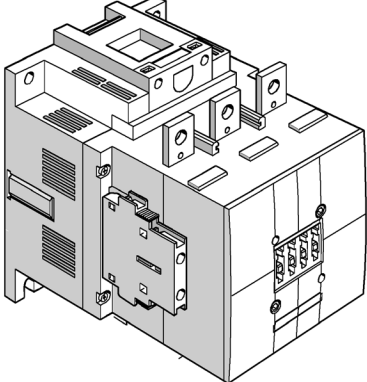
Size	3RT10 power contactors
S6	
S10 / S12	

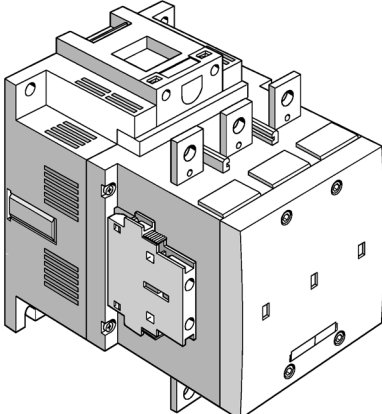
Size	3RT12 vacuum contactors
S10 / S12	

7.1 Switching and starting

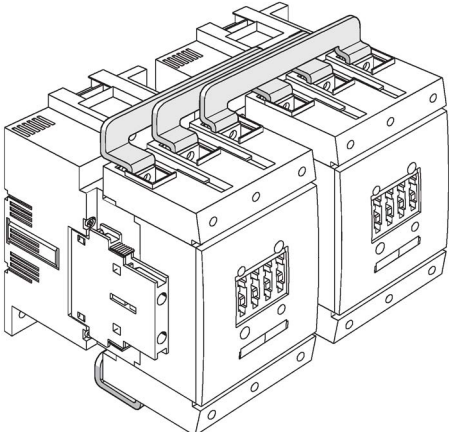
Size	Reversing contactor assembly (for self-assembly), size S6, as an example
S6 / S10 / S12	

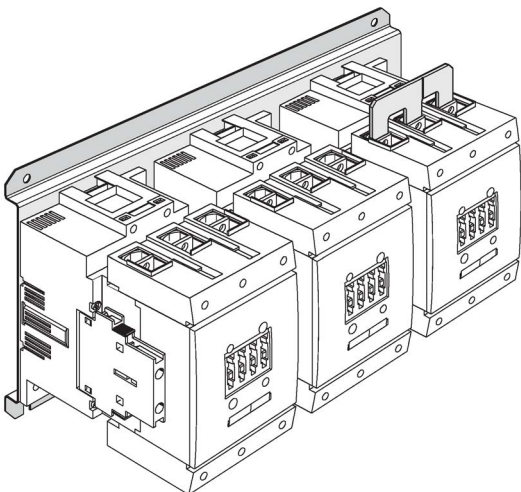
Size	Contactor assembly for star-delta (wye-delta) start (for self-assembly), size S6, as an example
S6 / S10 / S12	

7.1.1.2 Device versions

Various different switching devices are available for switching electrical loads. The contactor is the ideal device for performing switching operations which are frequently repeated. It is the most commonly used switching device in industry, mechanical engineering, and the manufacture of switching stations. 3RT2 contactors are available in sizes S00 to S3. 3RT1 contactors are available in sizes S6 to S12.

The SIRIUS range of contactors encompasses:

- 3RT.0 power contactors and 3RT12 vacuum contactors for switching motorized loads
- 4-pole 3RT23 contactors for switching resistive loads
- 3-pole 3RT24 / 3RT14 contactors for switching resistive loads
- 4-pole 3RT25 contactors for changing the polarity of hoisting gear motors
- 3RH2 contactor relays for switching in the control circuit
- 3RT26 capacitor contactors for switching capacitive loads (AC-6b)
- 3RT1 / 3RT2 / 3RH2 contactors with extended operating range
 - 3RT10 / 3RT20 / 3RH21 contactors for rail applications
 - 3RT20 / 3RH21 coupling relays for system-compliant interaction with electronic controllers
- Operation of a motor in two directions of rotation (reversing contactor assembly)
- Starting three-phase motors with reduced starting current peaks (contactor assemblies for star-delta (wye-delta) start)

Sizes

With its seven sizes, the SIRIUS contactor series covers the entire range up to 250 kW. Several standard motor ratings are available for each size.

7.1.1.3 Applications

Use and application areas

Various different switching devices are available for switching electrical loads. When frequent switching is necessary, the contactor is the ideal device.

Contactors are the most commonly used switching devices in industry, mechanical engineering and switchgear construction. The progressive automation of production plants has increased the significance of contactors, but this is also associated with higher and sometimes different requirements.

An automatic production system is significantly more sensitive to operating faults than manually operated systems. Every fault on an electrical device means a standstill, production downtime, and often substantial costs for recommissioning.

For this reason, value was placed on high operational reliability in the development of the SIRIUS contactor series. High service life, high contact reliability, and the option of using the contactors in the control cabinet at higher ambient temperatures are among the factors contributing to this. The contactors can be used at up to 60 °C and without derating even with side-by-side mounting.

Due to the diverse range application options, the range of contactors also encompasses versions for special applications such as switching resistive loads or switching capacitors, as well as the main 3RT20 and 3RT10 series for switching motorized loads.

The different contactor series with their possible application areas are explained in the following subsections.

Utilization categories

According to DIN EN 60947-4-1, the application area of and the load applied to power contactors can be identified by looking at the specified utilization category in conjunction with the specified rated operational current or the motor power and the rated voltage. The table below lists the most important utilization categories for contactors.

Utilization categories	
AC	Main circuit contacts: Utilization category for AC voltages
AC-1	Non-inductive or slightly inductive loads, resistance furnaces
AC-2	Slip-ring motors: starting, switching off
AC-3	Squirrel-cage motors: starting, switching-off motors during running
AC-4	Squirrel-cage motors: starting, plugging, inching
AC-5a	Switching of discharge lamp controls
AC-5b	Switching of incandescent lamps
AC-6a	Switching of transformers
AC-6b	Switching of capacitive loads
DC	Main circuit contacts: Utilization category for DC voltages
DC-1	Non-inductive or slightly inductive loads, resistance furnaces
DC-3	Shunt-wound motors: Starting, plugging, reversing, inching, dynamic braking
DC-5	Series-wound motors: Starting, plugging, reversing, inching, dynamic braking
AC	Auxiliary circuit contacts: Utilization category for AC voltages
AC-12	Control of resistive loads and solid-state loads with isolation by opto couplers
AC-14	Control of small electromagnetic loads (max. 72 VA)
AC-15	Control of electromagnetic loads (over 72 VA)
DC	Auxiliary circuit contacts: Utilization category for DC voltages
DC-12	Control of resistive loads and solid-state loads with isolation by opto couplers
DC-13	Control of electromagnets

7.1.1.4 SIRIUS 3RT2 contactors

3RT2 contactors up to 55 kW

SIRIUS 3RT2 contactors and contactor assemblies offer maximum flexibility in terms of dimensioning, handling, and function:

Table 7- 1 3RT2 contactors and contactor assemblies

Area	Customer benefits
Functions	<ul style="list-style-type: none"> • Power contactors (motors, resistive loads) and contactor relays • Conventional (S00, S0 and S2) and electronic drive (S0 and S2 only; reduced power consumption) • Contactors for switching capacitive loads (S00, S0 and S2) • Contactors with extended temperature range for railway applications • Function modules for mounting on contactors and for connection to the automation level (AS-i/IO-Link) • Reversing contactor: space-saving mechanical interlock for S00 and S0
Dimensioning and design	<ul style="list-style-type: none"> • Performance ranges: <ul style="list-style-type: none"> – S00 (7.5 kW, 16 A) – S0 (18.5 kW, 38 A) – S2 (37 kW, 80 A) – S3 (55 kW, 110 A) • Width: <ul style="list-style-type: none"> – S00 / S0 (45 mm) – S2 (55 mm) – S3 (70 mm) • Integrated auxiliary contacts • Identical auxiliary switch blocks for all sizes • Screw-type connection system, spring-loaded connection system (with S2 and S3 only in the control circuit), ring cable lug connection system (S00 and S0 only), solder pin connection system (S00 only)

Area	Customer benefits
Mounting advantages	<ul style="list-style-type: none"> • Contactor assemblies (for star-delta (wye-delta) start, reversing contactor assembly, 2 contactors in series) • Contactor assembly for star-delta (wye-delta) start: <ul style="list-style-type: none"> – Up to 90 kW – Control circuit wiring integrated in function modules, incl. electrical and mechanical interlock – Mechanical interlock (optionally available with S2) • Easy assembly of contactor assemblies and feeders by means of link modules for screw-type and spring-loaded terminals • Integrated cable duct for feeder-oriented assembly (with S0, S2 and S3)
Application areas/customer benefits	<ul style="list-style-type: none"> • Easy connection of feeders to the automation level via AS-Interface or IO-Link • Safety applications: Motor starter protectors in combination with <ul style="list-style-type: none"> – Undervoltage release and contactor usable in PL d/SIL 2 – Star-delta (wye-delta) starter usable in PL e/SIL 3 • Switching of capacitive loads: <ul style="list-style-type: none"> – Power capacitors in reactive-power compensation equipment – Switching on converters • For operation in installations that are subject both to considerable variations in the control voltage and to high ambient temperatures, e. g. railway applications under extreme climatic conditions • Switching of highly efficient IE3 / IE4 motors

Size-specific accessories for 3RT2 contactors (size S00)

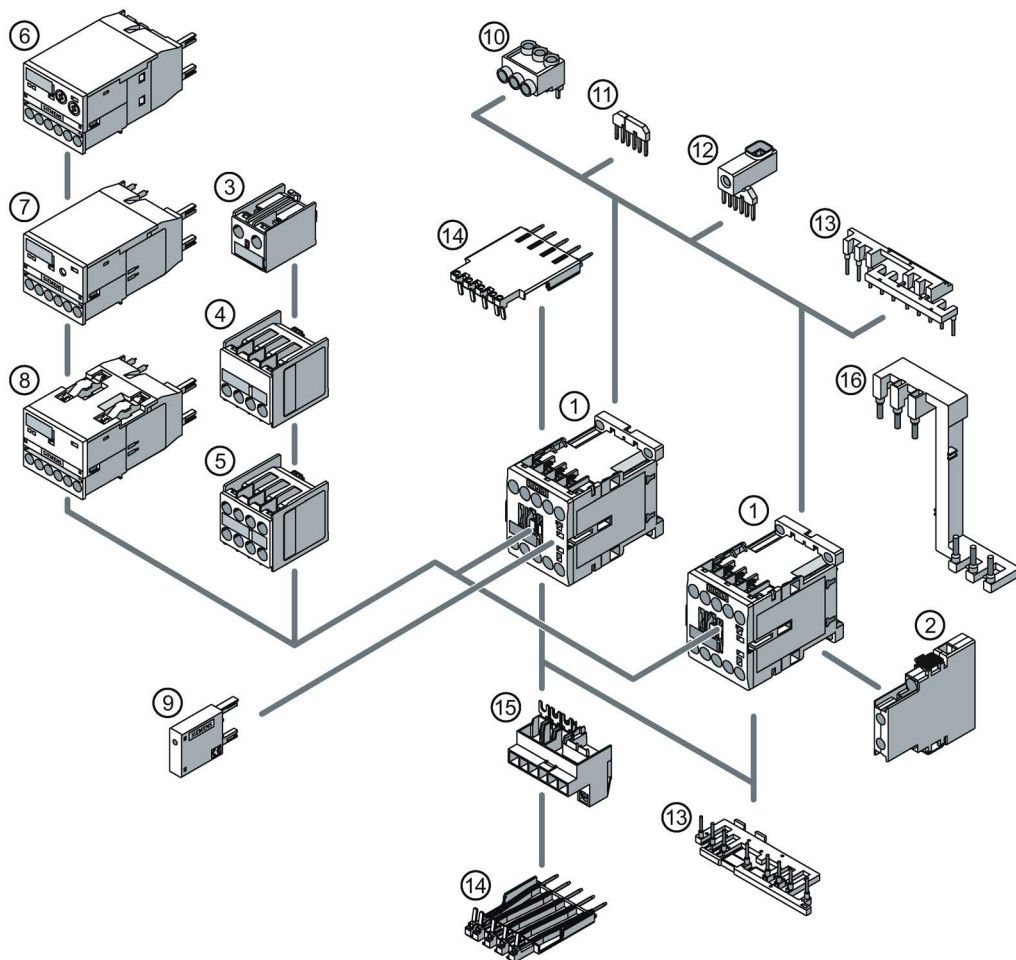

- 1 Contactor size S00
- 2 Laterally mountable auxiliary switch block (right or left), 2-pole
- 3 Auxiliary switch block for snapping onto the front, 1-pole (cable entry from above or below)
- 4 Auxiliary switch block for snapping onto the front, 2-pole (cable entry from above or below)
- 5 Auxiliary switch block for snapping onto the front, 4-pole
- 6 3RA28 function modules
- 7 Function module for AS-Interface, direct-on-line start
- 8 Function module for IO-Link, direct-on-line start
- 9 Surge suppressor
- 10 3-phase infeed terminal
- 11 Star jumper, 3-pole, without connection terminal
- 12 Parallel switching connector, 3-pole or 4-pole, with connection terminal
- 13 Wiring modules on the top and bottom, for connecting the main and control current paths
- 14 Solder pin adapter
- 15 Terminal module (adapter) for contactors with screw connections
- 16 Safety main circuit connectors for 2 contactors

Figure 7-1 Size-specific accessories for 3RT2 contactors (size S00)

Size-specific accessories for contactors (size S0)

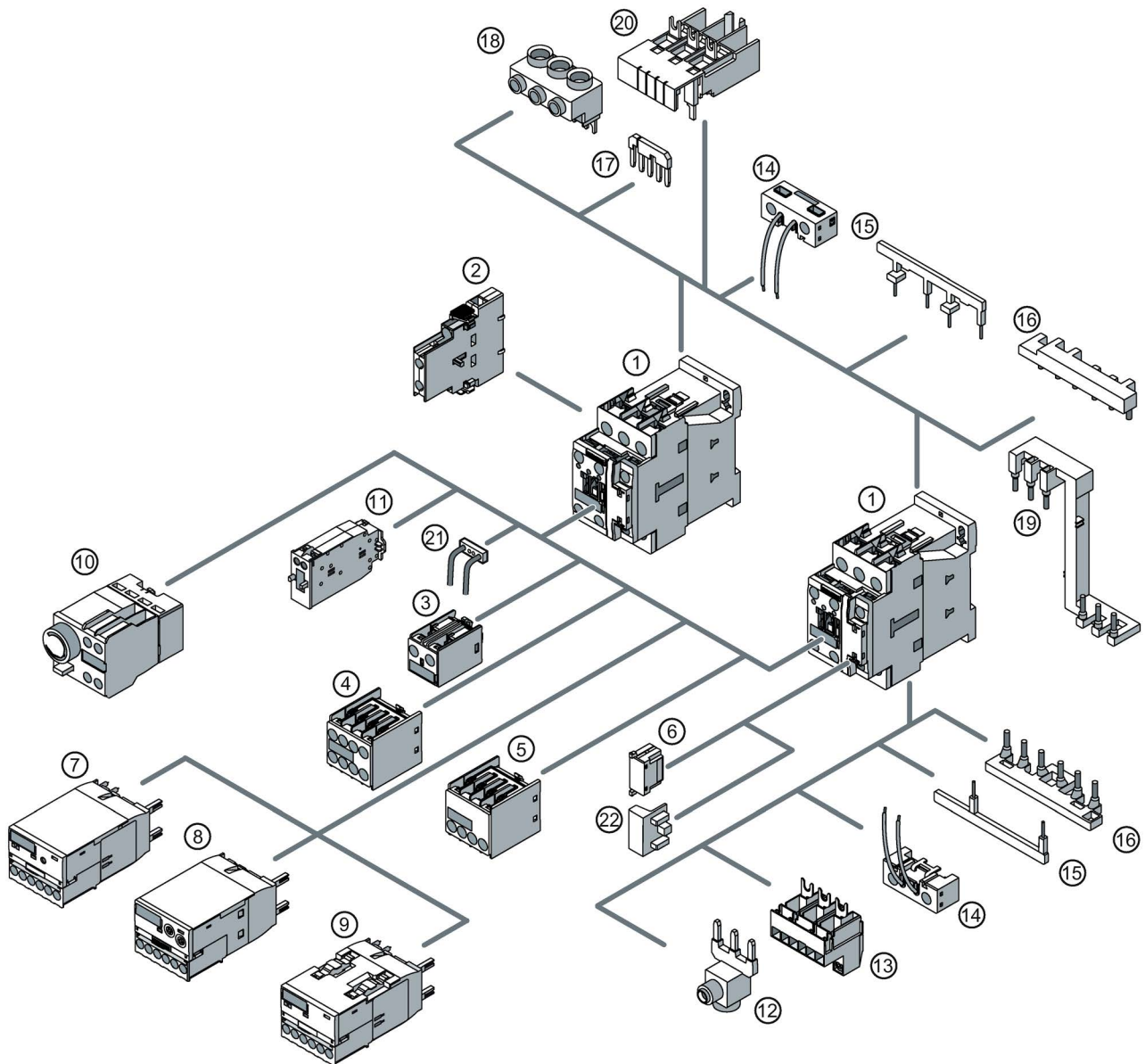

- 1 Contactor size S0
- 2 Laterally mountable auxiliary switch block (right or left), 2-pole
- 3 Auxiliary switch block for snapping onto the front, 1-pole (cable entry from above or below)
- 4 Auxiliary switch block for snapping onto the front, 4-pole
- 5 Auxiliary switch block for snapping onto the front, 2-pole (cable entry from above or below)
- 6 Surge suppressor
- 7 Function module for AS-Interface, direct-on-line start
- 8 3RA28 function modules
- 9 Function module for IO-Link, direct-on-line start
- 10 Pneumatic delay block
- 11 Mechanical latch

7.1 Switching and starting

- 12 Parallel switching connector
- 13 Terminal module (adapter) for contactors with screw connections
- 14 Coil terminal module, top and bottom
- 15 Wiring modules, top and bottom, for connecting the control current paths
- 16 Wiring modules, top and bottom, for connecting the main current paths
- 17 Star jumper, 3-pole, without connection terminal
- 18 3-phase infeed terminal
- 19 Link module for two contactors in series (safety main circuit connectors for two contactors)
- 20 Link module for motor starter protector
- 21 LED display indicator module
- 22 Control kit for manual operation of contactor contacts

Figure 7-2 Size-specific accessories for 3RT2 contactors (size S0)

Contactor accessories (size S2)

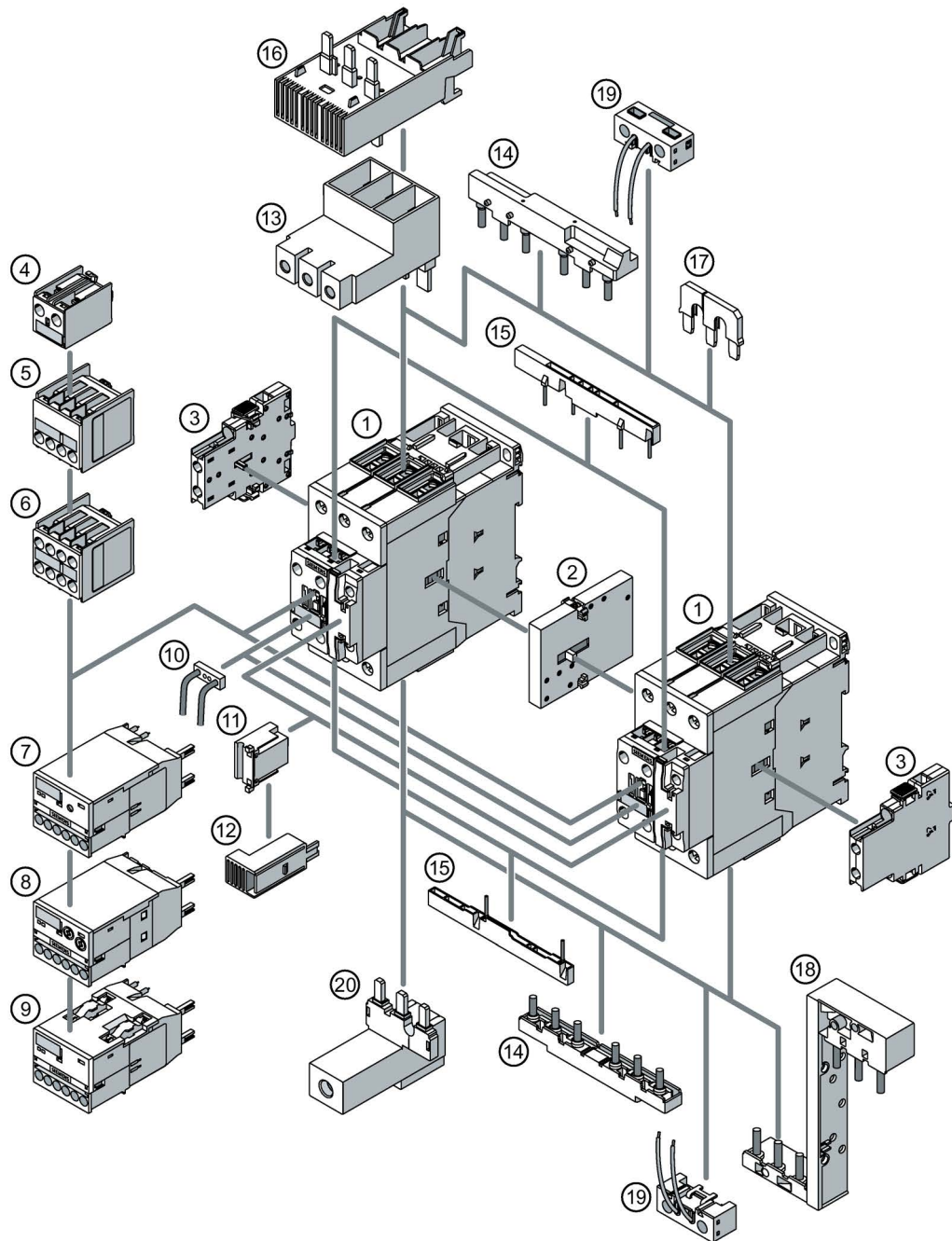

- 1 Contactor size S2
- 2 Mechanical interlock
- 3 Laterally mountable auxiliary switch block (right or left), 2-pole
- 4 Auxiliary switch block for snapping onto the front, 1-pole (cable entry from above or below)
- 5 Auxiliary switch block for snapping onto the front, 2-pole (cable entry from above or below)
- 6 Auxiliary switch block for snapping onto the front, 4-pole
- 7 Function module for AS-Interface, direct-on-line start

7.1 Switching and starting

- 8 3RA28 function modules
- 9 Function module for IO-Link, direct-on-line start
- 10 LED display indicator module
- 11 Surge suppressor
- 12 Control kit for manual operation of contactor contacts
- 13 3-phase infeed terminal (type E)
- 14 Wiring modules, top and bottom, for connecting the main current paths
- 15 Wiring modules, top and bottom, for connecting the control current paths
- 16 Link module for motor starter protector
- 17 Star jumper, 3-pole, without connection terminal
- 18 Link module for two contactors in series (safety main circuit connectors for two contactors)
- 19 Coil terminal module, top and bottom
- 20 Parallel switching connector

Figure 7-3 Accessories for 3RT2 contactors (size S2)

Accessories for contactors (size S3)

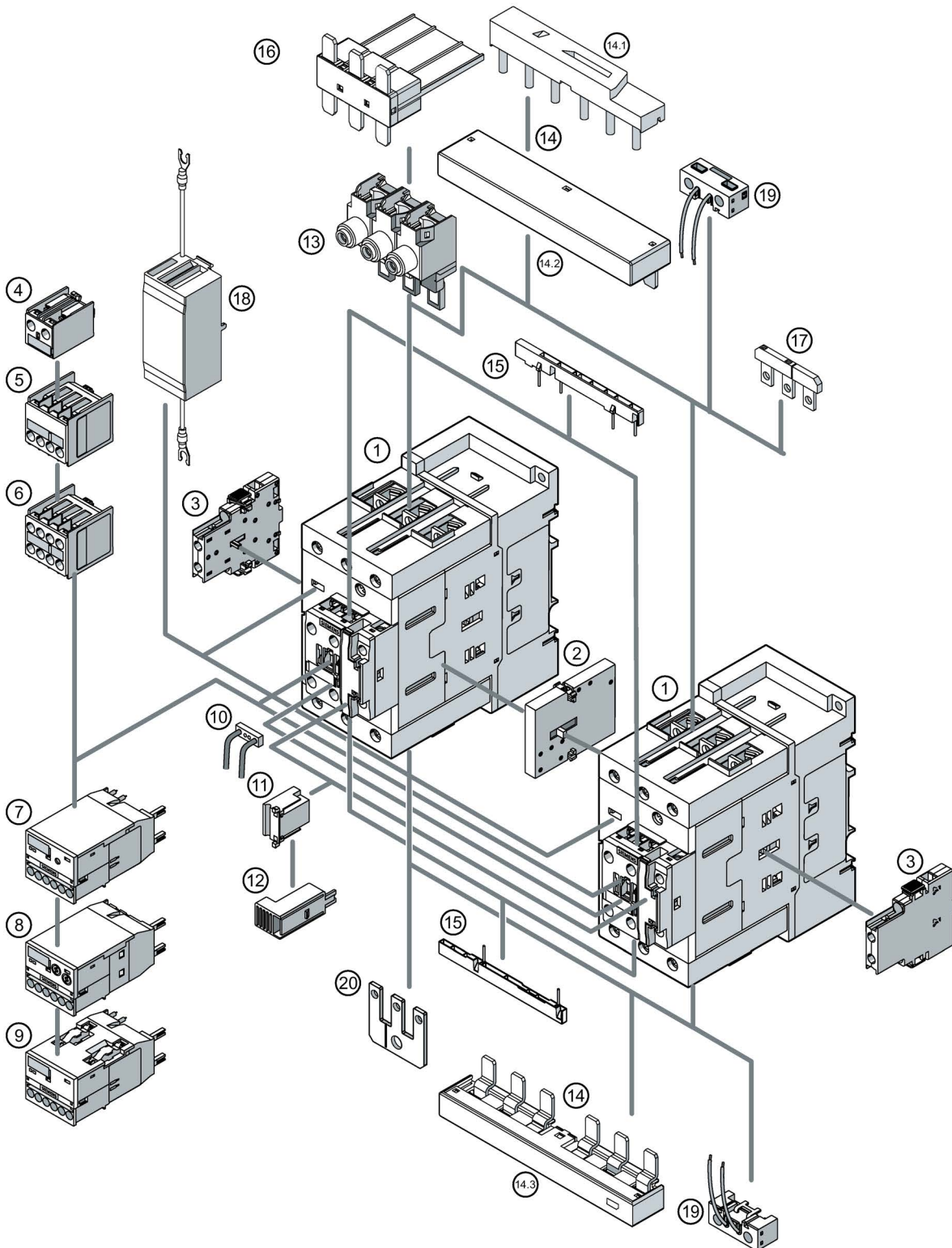

1 Contactor size S3

7.1 Switching and starting

- 2 Mechanical interlock
- 3 Laterally mountable auxiliary switch block (right or left), 2-pole
- 4 Auxiliary switch block for snapping onto the front, 1-pole (cable entry from above or below)
- 5 Auxiliary switch block for snapping onto the front, 2-pole (cable entry from above or below)
- 6 Auxiliary switch block for snapping onto the front, 4-pole
- 7 Function module for AS-Interface, direct-on-line start
- 8 3RA28 function modules
- 9 Function module for IO-Link, direct-on-line start
- 10 LED display indicator module
- 11 Surge suppressor without / with LED (varistor)
- 12 Control kit for manual operation of contactor contacts
- 13 Three 1-phase infeed terminals
- 14 Wiring modules, top and bottom, for connecting the main current paths
- 14.1 Wiring modules on the top for connecting the main current paths (contactor assembly for star-delta (wye-delta) start)
- 14.2 Wiring modules on the top for connecting the main current paths (reversing contactor assembly)
- 14.3 Wiring modules on the bottom for connecting the main current paths (reversing contactor assembly and contactor assembly for star-delta (wye-delta) start)
- 15 Wiring modules, top and bottom, for connecting the control current paths (reversing contactor assembly and contactor assembly for star-delta (wye-delta) start)
- 16 Link module for motor starter protector
- 17 Star jumper, 3-pole, without connection terminal
- 18 Surge suppressor without LED (RC element)
- 19 Coil terminal module, top and bottom
- 20 Parallel switching connector

Figure 7-4 Accessories for 3RT2 contactors (size S3)

7.1.1.5 SIRIUS 3RT1 contactors

3RT1 contactors up to 250 kW

SIRIUS 3RT1 contactors and contactor assemblies offer maximum flexibility in terms of dimensioning, handling and function:

Table 7- 2 3RT1 contactors

Area	Customer benefits
Functions	<ul style="list-style-type: none"> • Power contactors (motors, resistive loads) • Vacuum contactors (electrical loads) • Conventional operating mechanisms • Solid-state operating mechanisms (for 24 V DC PLC output and for 24 V DC PLC output with remaining lifetime indicator)
Dimensioning and design	<ul style="list-style-type: none"> • Performance ranges: <ul style="list-style-type: none"> – S6 (90 kW, 185 A) – S10 (160 kW, 185 A) – S12 (250 kW, 500 A) • Width: <ul style="list-style-type: none"> – S6 (120 mm) – S10 (145 mm) – S12 (160 mm) • Factory-assembled auxiliary contacts (2 NC contacts and 2 NO contacts) • Identical auxiliary switch blocks for all sizes • Screw-type connection system, spring-loaded connection system, bus connection system, box terminal connection

7.1 Switching and starting

Area	Customer benefits
Mounting advantages	<ul style="list-style-type: none"> • Assembly of reversing contactor assemblies up to 250 kW and contactor assemblies for star-delta (wye-delta) start up to 500 kW with wiring kits for customer assembly • Wiring kit for reversing contactor assembly: <ul style="list-style-type: none"> – Mechanical interlocks – Mechanical connectors – Wiring modules on the top and bottom for contactors with box terminal block and bus connection – Base plates • Wiring kit for contactor assembly for star-delta (wye-delta) start: <ul style="list-style-type: none"> – Mechanical connectors – Neutral bridges – Wiring modules on the bottom for contactors with box terminal block and bus connection – Base plates • Easy assembly of contactor assemblies by means of link modules for screw-type and spring-loaded terminals
Application areas/customer benefits	<ul style="list-style-type: none"> • For operation in installations that are subject both to considerable variations in the control voltage and to high ambient temperatures, e. g. railway applications under extreme climatic conditions • Comprehensive approvals for global applicability

Size-specific accessories for 3RT1 contactors (sizes S6 to S12)

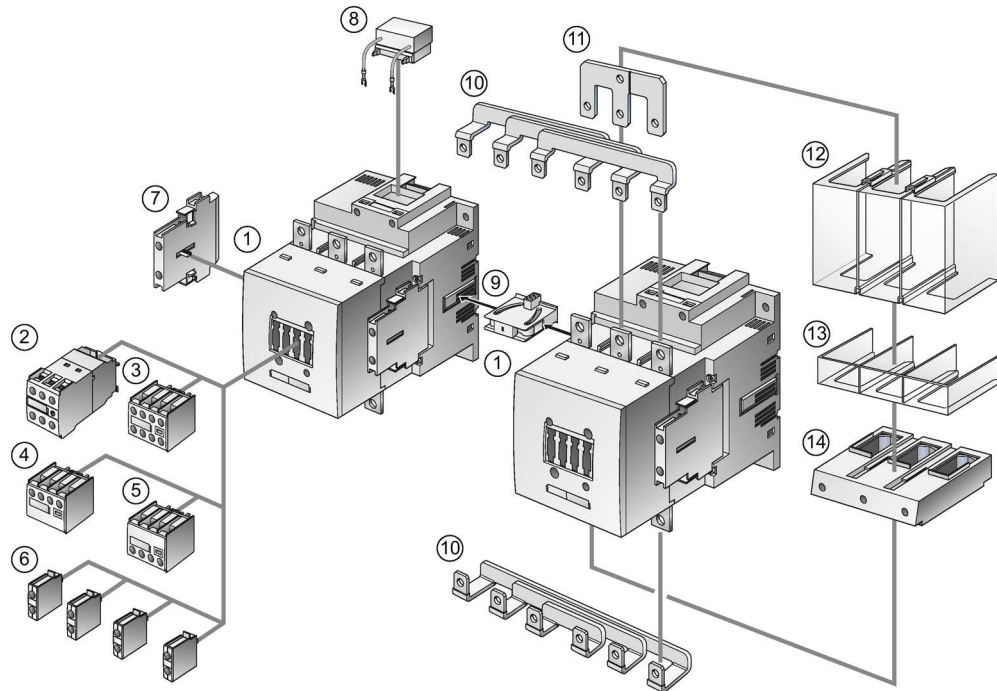

- ① 3RT10 and 3RT14 air-break contactor, sizes S6, S10 and S12
- ② Auxiliary switch block, electronically delayed (ON-delay or OFF-delay or star-delta (wye-delta) function)
- ③ 4-pole auxiliary switch block (terminal designations according to EN 50 012 or EN 50 005)
- ④ 2-pole auxiliary switch block, cable entry from above
- ⑤ 2-pole auxiliary switch block, cable entry from below
- ⑥ 1-pole auxiliary switch block (max. 4 can be snapped on) (terminal designations according to EN 50 012 or EN 50 005)
- ⑦ 2-pole auxiliary switch block, attachable on the right or left side (terminal designations according to EN 50 012 or EN 50 005)
- ⑧ Surge suppressor (RC element), can be attached at the top on the withdrawable coil
- ⑨ Mechanical interlock, laterally mountable
- ⑩ Wiring modules top and bottom (reversing duty)
- ⑪ Parallel connector (neutral bridge), 3-pole with through hole, different for sizes S6 and S10/S12
- ⑫ Connection cover for cable lug and bar connection, different for sizes S6 and S10/S12
- ⑬ Cover for box terminal, different for sizes S6 and S10/S12
- ⑭ Box terminal block, different for sizes S6 and S10/S12
- ② to ⑨ Same accessories for sizes S6 to S12
- ⑩ to ⑭ Different accessories depending on size

Reference

More information ...	Is available in ...
about the 3RT, 3RH2 and 3RA23 / 3RA24 contactors and contactor assemblies	section "Manuals - SIRIUS Modular System (Page 26)" in the "SIRIUS - SIRIUS 3RT Contactors/Contactor Assemblies" manual

7.1.2 3RA27/3RA28 function modules



Figure 7-5 Function modules

Function modules are used to perform various control jobs on automatic production lines and for processing machines. They are suited to all time-delayed switching operations in control, starting, protection, and regulation circuits, and ensure a high degree of repeat accuracy for delay times, once they have been set.

Function modules are divided into those with a communication connection (AS-Interface or IO-Link) and those without a communication connection.

Communication-capable 3RA27 function modules are available for the following contactors and contactor assemblies:

- For direct-on-line start
- For reversing start
- For star-delta (wye-delta) start

7.1.2.1 3RA27 function modules for connection to the higher-level control

3RA27 function modules are integrated into the higher-level control system via an IO-Link master or AS-Interface. They facilitate the simple exchange of data with the control.

Communication-capable function modules are mounted on contactors or contactor assemblies with a communication connection from the SIRIUS device family.

Table 7- 3 3RA27 function modules for connection to the automation level

Area	Customer benefits
Functions	<ul style="list-style-type: none"> • Connection of direct-on-line, reversing, and star-delta (wye-delta) starters to the automation level • Function modules with IO-Link or AS-i interface • 2- or 3-wire communication to the control • Integrated logic functions for starter types • Replacement of laborious control circuit wiring • Additional diagnostics via IO-Link.
Dimensioning and design	<ul style="list-style-type: none"> • One module for sizes S00, S0, S2 and S3 • Standard motor starter profile for all starter types • Starter-oriented configuration in the TIA environment • IO-Link: <ul style="list-style-type: none"> – Up to 4 feeders in one group per channel on the master – Addressing not required • AS-i <ul style="list-style-type: none"> – One address per feeder – Max. 62 addresses
Mounting advantages	<ul style="list-style-type: none"> • Just a few cable connections to the control • Considerably minimized wiring complexity within a starter • Also available as pre-assembled contactor assemblies (e.g. star-delta (wye-delta) starters) • No control circuit wiring to the motor starter protector (voltage check) • Available with screw-type and spring-loaded connection systems
Application areas/customer benefits	<ul style="list-style-type: none"> • Easy and fast connection of a load feeder to the control • Reduced number of I/O channels on the control • Easy and fast configuration • Improved transparency through integrated diagnostics

Assembly

With the 3RA27 function modules, feeder functions are realized with contactors and a connection is established with the control. This connection is realized via IO-Link or AS-i (3RA2712) or via parallel wiring (3RA28).

Table 7- 4 Assembly of 3RA27 function modules

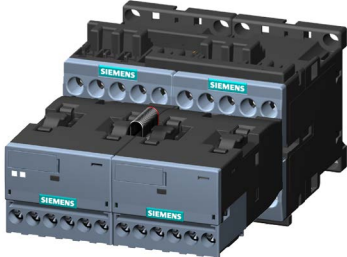
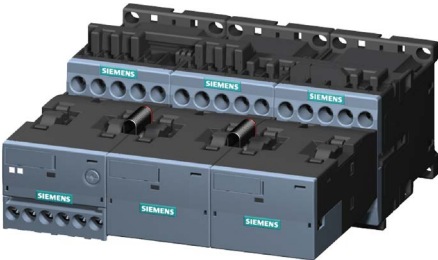
Type of starter	Assembly
Direct-on-line start	 <p>The image shows a Siemens 3RA27 Direct-on-line starter assembly. It consists of a main contactor (3RA28) and a thermal relay (3RA27) mounted on a common rail. The contactor has three main contacts and a control terminal block. The thermal relay is mounted on top of the contactor and has a control terminal block on its side.</p>
Reversing start	 <p>The image shows a Siemens 3RA27 Reversing starter assembly. It consists of two main contactors (3RA28) and a thermal relay (3RA27) mounted on a common rail. The contactors are arranged in a reversing configuration, with one contactor on top and one on the bottom. The thermal relay is mounted in the middle. The contactors have three main contacts and a control terminal block. The thermal relay has a control terminal block on its side.</p>
Star-delta (wye-delta) start	 <p>The image shows a Siemens 3RA27 Star-delta (wye-delta) starter assembly. It consists of three main contactors (3RA28) and a thermal relay (3RA27) mounted on a common rail. The contactors are arranged in a star-delta configuration, with one contactor on top and two on the bottom. The thermal relay is mounted in the middle. The contactors have three main contacts and a control terminal block. The thermal relay has a control terminal block on its side.</p>

Function modules for IO-Link

Function modules for IO-Link are integrated in the higher-level control system via an IO-Link master. They are mounted on contactors with a communication link or contactor assemblies with a communication link from the SIRIUS device family.

The function modules for IO-Link comply with the IO-Link communication specification V1.1.

The function modules for IO-Link are available for the following contactors and contactor assemblies:

- For direct starting
- For reversing starting
- For star-delta starting

The function modules are divided into basic modules and coupling modules. Coupling modules are connected with the basic module or another coupling module via module connectors.

The process image of the function module outputs controls the starter. The process image of the inputs represents the status of the starter.

Operator panel

The starters are controlled with the operator panel in manual mode. The states of the device are also queried for up to 4 starters.

The operator panel is connected to the last available interface of a starter group via the 10-core connecting cable.

The voltage supply of the operator panel is provided with the 2 m long connecting cable.

Note

If communication between the IO-Link master and IO-Link device is interrupted, the IO-Link devices switch off connected loads for safety reasons.

Manual operation is still possible with the operator panel.

Reference

More information ...	Is available in ...
about the 3RA2711 function modules for IO-Link	Section "Manuals - SIRIUS Modular System (Page 26)" in the "SIRIUS - SIRIUS 3RA2711 function modules for IO-Link" manual.

Function modules for AS-Interface

Function modules for AS-Interface are mounted on contactors or contactor combinations of the SIRIUS device family, and they connect these with the AS-Interface.

The function modules for AS-Interface are available for the following contactors and contactor combinations:

- For direct starting
- For reverse starting
- For star-delta starting

The function modules are divided into basic modules and coupling modules. Coupling modules are connected with the basic module or another coupling module via module connectors.

Basic modules are connected with the AS-Interface using a removable terminal. For this purpose, the AS-Interface cable and the auxiliary voltage are connected to the basic module's removable terminal.

The process image of the function modules controls the starter. The process image of the inputs represents the status of the starter.

AS-i addressing unit

The AS-i addressing unit can be used to control the contactors and display the process image independently of the AS-i bus.

Reference

More information ...	Is available in ...
about the 3RA2712 function modules for AS-Interface	Section "Manuals - SIRIUS Modular System (Page 26)" in the "SIRIUS - SIRIUS 3RA2712 function modules for AS-Interface" manual.

7.1.2.2 SIRIUS 3RA28 function modules for mounting on 3RT2 contactors





SIRIUS 3RA28 function modules for mounting on SIRIUS 3RT2 contactors enable the control circuit wiring to be reduced significantly. With star-delta (wye-delta) starters, for example, they replace the control circuit wiring in its entirety.

Table 7- 5 3RA28 function modules for mounting on 3RT2 contactors

Area	Customer benefits
Functions	<ul style="list-style-type: none"> • Direct-on-line, reversing, and star-delta (wye-delta) start • Time-delayed switching of contactors (0.05 ... 100 s) • ON-delay and OFF-delay versions • Star-delta (wye-delta) function module without extra control circuit wiring • Switch position indication for the contactor via a mechanical plunger
Dimensioning and design	<ul style="list-style-type: none"> • Only one version for S00, S0, S2 and S3 • Suitable for control voltages of 24 to 240 V AC/DC • Contactor coil controlled via semiconductor output • Star-delta (wye-delta) switchover 0.5 to 60 s • Star-delta (wye-delta) changeover delay ≥ 50 ms
Mounting advantages	<ul style="list-style-type: none"> • Easy plug-on assembly of a starter, without tools • Removable terminals • Screw-type and spring-loaded terminals
Application areas/customer benefits	<ul style="list-style-type: none"> • Assembly of star-delta (wye-delta) starters, including timing function and electrical interlock, without additional wiring • Universal applicability thanks to wide voltage and time ranges

Assembly

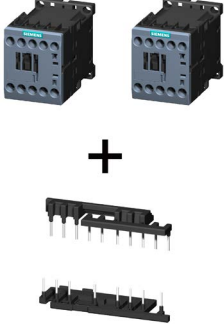
With 3RA28 function modules, a starter can be easily assembled by combining individual modules together or by using pre-assembled combinations.

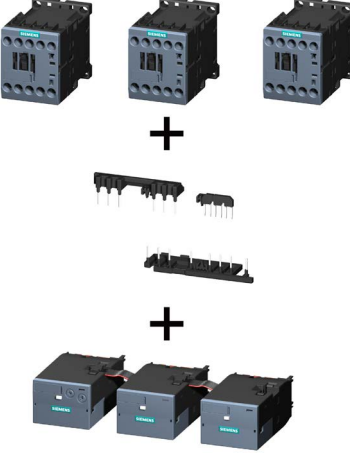
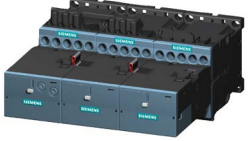
Type of starter	Individual modules	Pre-assembled combinations
Direct-on-line start		
Reversing start		
Star-delta (wye-delta) start		

Applications

Function modules are used to perform various control jobs on automatic production lines and for processing machines. They are suited to all time-delayed switching operations in control, starting, protection, and regulation circuits, and ensure a high degree of repeat accuracy for delay times, once they have been set.

The function modules are subdivided into function modules with communication interfacing and function modules without communication interfacing.

Function modules	
3RA28 function modules	Electronic timing relays with semiconductor output
	Solid-state time-delay auxiliary switches
	Function module for star-delta (wye-delta) start
3RA27 function modules with communication connection	Function modules for AS-Interface
	Function modules for IO-Link

This chapter describes 3RA28 function modules without a communication connection. You will find information about function modules with a communication connection in the corresponding manuals.

Function

Function modules are used to delay switching functions.

System integration

The 3RA28 function modules have been matched to the contactors in the 3RT2 and 3RH2 series¹⁾ both electrically and mechanically, and can be integrated in the feeders by directly mounting them on contactors. The function modules can be used for size S00, S0, S2 and S3 contactors.

The 3RA27 function modules can only be used for communication-capable contactors.

¹⁾ The 3RA28 function modules must not be mounted on 3RH2 coupling relays.

Connection system

Users can choose either function modules with screw-type connection system or function modules with spring-loaded connection system.

Device versions

- Function modules for direct-on-line start
 - Solid-state timing relays with semiconductor output
 - Solid-state time-delay auxiliary switches
- Function modules for star-delta (wye-delta) start

Characteristics

The table below provides an overview of the versions of 3RA28 function modules for mounting on 3RT2 and 3RH2 contactors¹⁾.

¹⁾ The 3RA28 function modules must not be mounted on 3RH2 coupling relays.

Characteristic	Versions			
	Function modules for direct-on-line start		Function module for star-delta (wye-delta) start	
	Electronic timing relay with semiconductor output	Solid-state time-delay auxiliary switches		
Function	ON-delay and OFF-delay with control signal	ON and OFF-delay with/without control signal	Star-delta (wye-delta) function	
Article numbers	3RA2811-.CW10/ 3RA2812-.DW10	3RA2831-.D.10/ 3RA2832-.D.10	3RA2813-..W10/ 3RA2814-..W10/ 3RA2815-..W10	3RA2816-0EW20 comprising: 1 basic module 2 coupling modules
Size	For size S00, S0 contactors.	For size S2 and S3 contactors.	One module for size S00, S0, S2 and S3 contactors.	
Width	45 mm		135 mm (3 x 45 mm)	
Connection system	Screw-type, spring-loaded		Without terminals (can be used for contactor screw-type and spring-loaded connection systems)	

Function modules for direct-on-line start

Applications

The function modules for direct-on-line start are used for the time-delayed switching of contactors. The following function modules are available:

- Electronic timing relay with semiconductor output
- Solid-state time-delay auxiliary switch with 1 CO contact or 1 NC contact/1 NO contact

Features of direct-on-line starters

The function module for direct-on-line start has the following features:

- All modules with wide control voltage range
- Integrated varistor (surge suppressor)
- Applicable for size S00, S0, S2 and S3 contactors.

The following table is an overview of which function modules you can use for which size of contactors.

	S00	S0	S2	S3
3RA2811, 3RA2812	X	X	-	-
3RA2831, 3RA2832	-	-	X	X
3RA2813, 3RA2814, 3RA2815	X	X	X	X

- Large wide voltage range (24 ... 240 V AC/DC), except for 3RA2831, 3RA2832
- Extended operating ranges (24 ... 90 V, 90 ... 240 V), for 3RA2831 and 3RA2832 only
- 3 selectable time ranges (1 s, 10 s, 100 s)
- Operating time adjustment from 5 ... 100% per time range
- Switch position indicator for the contactor below (plunger)

Function modules for star-delta (wye-delta) start

Applications

The function module for star-delta (wye-delta) start is used to switch from star (wye) to delta operation.

Features

The function module for star-delta (wye-delta) start has the following features:

- All modules with wide control voltage range
- Integrated varistor (surge suppressor)
- One module kit for contactor screw-type and spring-loaded connection systems
- One module kit for S00, S0, S2 and S3 size contactors (options only with main circuit connecting comb)
- Large wide voltage range (24 to 240 V AC/DC) and
- 3 selectable time ranges (10 s, 30 s, 60 s)
- Operating time adjustment from 5 to 100% per time range (corresponds to 0.5 s to 60 s)
- Changeover delay set to a non-adjustable value of ≥ 50 ms
- Switch position indication for the contactor below in the form of a mechanical switch position indicator (plunger)
- Control exclusively via A1/A2 on the line contactor below
- No further wiring required

The wide voltage and the wide time range ensure advanced use of the function modules.

3RA2816-0EW20 function module for contactor assemblies for star-delta (wye-delta) start

The function module for plugging into contactor assemblies for star-delta (wye-delta) start for sizes S00, S0, S2 and S3 comprises the following devices:

- 1 basic module with time setting
- 2 coupling modules with corresponding connecting cable to coupling or function module

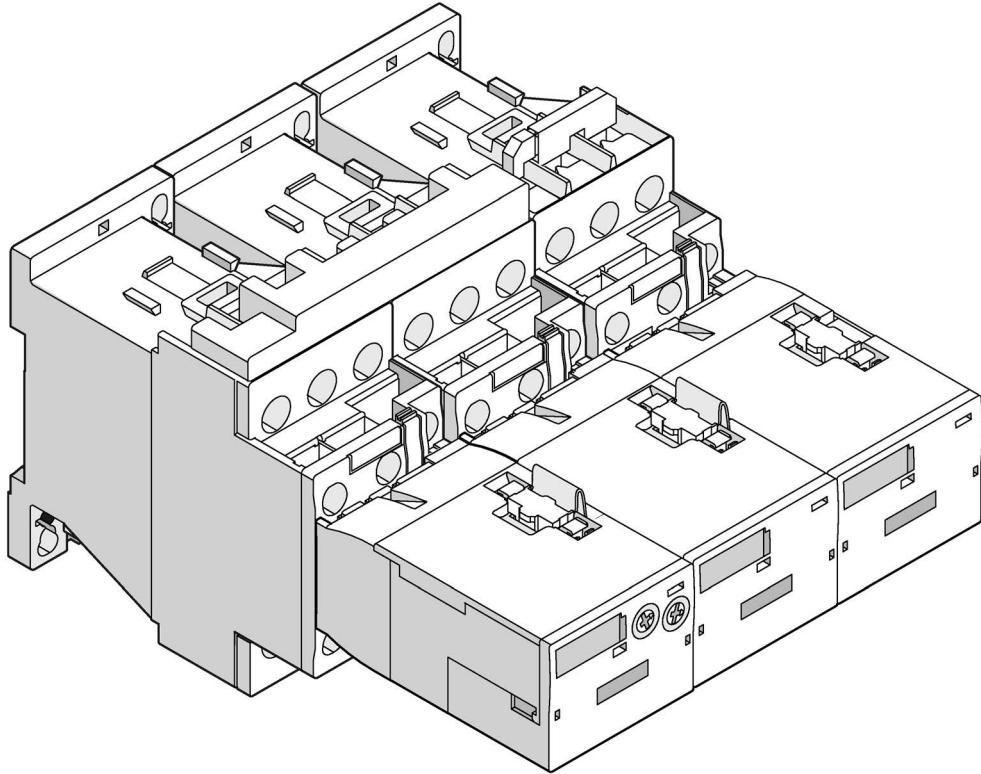

Figure 7-6 Star-delta (wye-delta) starter, completely assembled

The function module replaces the entire control circuit wiring and combines the functions of the following devices and tasks:

- Timing relay star-delta (wye-delta) function
- Auxiliary switches
- Auxiliary conductor wiring
- Electrical interlock
- Switch position indicator for the contactor below (plunger)

Note**Fitting of auxiliary switches**

When the 3RA2816-0EW20 function module for star-delta (wye-delta) start is used, the following applies:

No more than one 3RH29 lateral auxiliary switch block (product version E03 and higher) may be mounted onto the line contactor (Q11) and onto the star (wye) contactor (Q12).

Reference

More information ...	Is available in ...
about the 3RA28 function modules for mounting on 3RT2 contactors	Section "Manuals - SIRIUS Modular System (Page 26)" in the "SIRIUS - SIRIUS 3RA28 function modules for mounting on 3RT2 contactors" manual.

7.1.3 3RF34 solid-state switching devices

3RF34 solid-state switching devices



Figure 7-7 Solid-state switching device

SIRIUS 3RF34 solid-state switching devices feature a heat sink integrated in the insulated enclosure, so no grounding is required.

Table 7- 6 3RF34 solid-state switching devices

Area	Customer benefits
Functions	<ul style="list-style-type: none"> Instantaneous switching solid-state contactors for motor switching Direct-on-line and reversing contactor (integrated electric interlock).
Dimensioning and design	<ul style="list-style-type: none"> S0 (0.5 to 16 A) Width 45 mm (2.2 kW/5.4 A) or 90 mm (7.5 kW/16 A) 24 V DC and 110 to 230 V AC Rated voltage up to 600 V Insulated enclosure Optimized sizing and few power versions up to 7.5 kW Screw-type and spring-loaded terminals
Mounting advantages	<ul style="list-style-type: none"> Side-by-side assembly possible Easy connection to the motor starter protector by means of link module Connection option for electronic overload relay or current monitoring relay Removable terminals for auxiliary circuit wiring
Application areas/customer benefits	<ul style="list-style-type: none"> Wear- and noise-free operation for frequent motor switching Long service life (over 100 million operating cycles) Comprehensive approvals for global applicability

7.1.3.1 Device versions

Solid-state switching devices are primarily used in single-phase applications, which have to meet the following requirements:

- Very high switching frequencies (> 1000 switching operations per hour)
- Resistive loads

The SIRIUS modular system features single- and three-phase solid-state contactors and solid-state relays for the frequent switching of resistive loads. Three-phase solid-state contactors and solid-state reversing contactors are available for switching motorized loads. Standardized function modules for various applications complete the range of SIRIUS solid-state switching devices.

The solid-state contactor and solid-state reversing contactor versions listed in this manual are intended specifically for operation on three-phase motors up to 7.5 kW.

Overview

These 2-phase controlled instantaneous switching solid-state switching devices are operated in two mounting widths in an insulating enclosure:

- In 45 mm width
 - Up to 5.2 A as solid-state contactor (motor contactor) or
 - Up to 5.4 A as solid-state reversing contactor and
- In 90 mm width
 - Up to 16 A as solid-state contactor or
 - Up to 7.4 A as solid-state reversing contactor

This means that it is possible to operate motors up to 7.5 kW.

The solid-state contactors and solid-state reversing contactors for screw-type connection can be connected directly to a motor starter protector with a 3RA2921-1BA00 link module. Direct mounting of a 3RB30/3RB31 solid-state overload relay and, in some cases, a 3RR2 current monitoring relay, is also possible. This provides a time-saving way of implementing rapid-switching motor feeders with and without fuses.

Versions

The following table provides an overview of the versions of the 3RF34 instantaneous switching solid-state contactors for switching motors.

Table 7- 7 Versions of solid-state switching devices

Characteristic	Versions	
Version	Solid-state contactor	Solid-state reversing contactor
Description	Complete devices in insulated enclosures for frequent switching on and switching off of AC drives.	Compact design of the reversing circuit for frequent switching on and switching off of AC drives with continuous reversal of the direction of rotation
Order numbers	3RF34..-BB..	3RF34..-BD..
Size	S0	
Width (motor power ¹⁾ /max. rated operational current)	<ul style="list-style-type: none"> • 45 mm (motors up to 2.2 kW, 5.2 A) • 90 mm (motors up to 7.5 kW, 16 A) 	<ul style="list-style-type: none"> • 45 mm (motors up to 2.2 kW, 5.4 A) • 90 mm (motors up to 3.0 kW, 7.4 A)
Number of poles	3	3
Connection system	Screw-type and spring-loaded terminals	Screw-type
Rated operating voltage	Up to 600 V	Up to 480 V
Rated control supply voltage	24 V DC and 110 to 230 V AC	
Switching delay		
ON-delay	1 ms (24 V DC), 5 ms (110 to 230 V AC)	5 ms (24 V DC), 20 ms (110 to 230 V AC)
OFF-delay	1 ms (24 V DC), 30 ms (110 to 230 V AC) plus up to one half-wave	5 ms (24 V DC), 10 ms (110 to 230 V AC) plus up to one half-wave
Interlock time	60 to 100 ms (24 V DC), 50 to 100 ms (110 to 230 V AC)	
Enclosure	Insulated (no grounding required)	
Control connections	Screw-type connection system and spring-loaded connection system, removable terminal for auxiliary circuit wiring (2 contacts)	Screw-type connection system, removable terminal for auxiliary circuit wiring (3 contacts)

¹⁾ Rating data relates to 400 V line voltage

7.1.3.2 Applications

Solid-state switching devices for switching motors

The **solid-state contactors** for the wear-free and noiseless switching of motors are designed for the frequent switching on and switching off of AC drives up to 7.5 kW as well as for reversing up to 3.0 kW. The devices are fully insulated and can be mounted directly on motor starter protectors and overload relays or SIRIUS current monitoring relays, which makes them really easy to integrate into motor feeders.

These 3-phase solid-state contactors are equipped with a 2-phase control which is particularly suitable for typical motor circuits without a connection to the neutral conductor.

The integration of four current paths to form a single reversing circuit, accommodated in one enclosure, makes the **solid-state reversing contactor** a particularly compact solution. Unlike conventional systems which require two contactors, width can be reduced by up to 50% with the 3-phase solid-state reversing contactors. Devices with a width of 45 mm cover motors up to 2.2 kW and those with a width of 90 mm cover motors up to 3 kW.

Integration in the SIRIUS modular system facilitates connection to a SIRIUS motor starter protector via a link module or to a 3RB30/3RB31 solid-state overload relay or a 3RR2 current monitoring relay without additional steps. As a result, fuseless or fused motor feeders can be implemented quickly and easily.

Main features:

- Insulated enclosure with integrated heat sink
- Degree of protection IP20
- Integrated mounting foot for snapping on a DIN rail or mounting on a support plate
- Variety of connection systems
- Plug-in control connection
- LED to indicate control voltage

Reference

More information ...	Is available in ...
about the 3RF34 solid-state switching devices	section "Manuals - SIRIUS Modular System (Page 26)" in the "SIRIUS - SIRIUS 3RF34 Solid-State Switching Devices" manual.

7.1.4 SIRIUS 3RW30/40 soft starters

3RW30/40 soft starters



Figure 7-8 S0 soft starter

SIRIUS 3RW30 soft starters for standard applications in 200 – 480 V systems (3RW40: 200 – 600 V) offer basic functionality at cost-optimized prices:

Table 7- 8 3RW30/40 soft starters

Area	Customer benefits
Functions	<ul style="list-style-type: none"> • Soft starting for simple startup conditions • Integrated bypass contact system • Integrated protection functions for motor starter and soft starter (3RW40) • Two-phase "polarity balancing" control method (consistently up to 250 kW) • Thermistor motor protection (optional with 3RW40) • Settable current limiting (3RW40)
Dimensioning and design	<ul style="list-style-type: none"> • Performance ranges: <ul style="list-style-type: none"> – S00 up to (7.5 kW, 17.6 A) – S0 up to (18.5 kW, 38 A) – S2 up to (37 kW, 72 A) – S3 up to (55 kW, 106 A) • Width: <ul style="list-style-type: none"> – S00 / S0: 45 mm – S2: 55 mm – S3: 70 mm • Screw-type and spring-loaded terminals
Mounting advantages	<ul style="list-style-type: none"> • Easy commissioning and maintenance • Easy retrofitting with wiring already installed • Parameterizable output (3RW40)
Application areas/customer benefits	<ul style="list-style-type: none"> • Considerable power savings through integrated bypass contact system • Adjustable tripping classes (3RW40) • Integrated diagnostics functions (3RW40)

7.1.4.1 Applications and use

Applications and selection criteria

The SIRIUS 3RW30 and 3RW40 soft starters represent a good alternative to direct or wye-delta starters.

The most important advantages are:

- Soft start
- Soft stop (3RW40 only)
- Uninterrupted switching without current peaks that place a heavy load on the system
- Simple installation and commissioning
- Compact, space-saving design

Applications

The typical applications include:

- Conveyor belts
- Roller conveyors
- Compressors
- Fans
- Pumps
- Hydraulic pumps
- Agitators
- Circular saws / band saws

Advantages

Conveyor belts and transport systems:

- Smooth starting
- Smooth stopping

Rotary pumps and piston pumps:

- No pressure surges
- Increased service life of the pipe system

Agitators and mixers:

- Reduced starting current

Fans:

- Protection for the gearbox and V belt

7.1 Switching and starting

7.1.4.2 Fields of application

Soft starters are used to start three-phase induction motors with reduced torque and reduced starting current.

SIRIUS soft starter family

The SIEMENS SIRIUS soft starter family comprises three different versions with different functionalities and prices.

3RW30 and 3RW40

Simple or standard applications are covered by the SIRIUS 3RW30 and 3RW40 soft starters and are described in a separate manual.

3RW44

The SIRIUS 3RW44 soft starter is used if higher functionality is specified, e.g. communication over PROFIBUS or the availability of measuring and monitoring values, as well as for ultra-heavy-duty starting. The SIRIUS 3RW44 soft starter is described in a separate system manual.

Accessories for 3RW30 soft starters

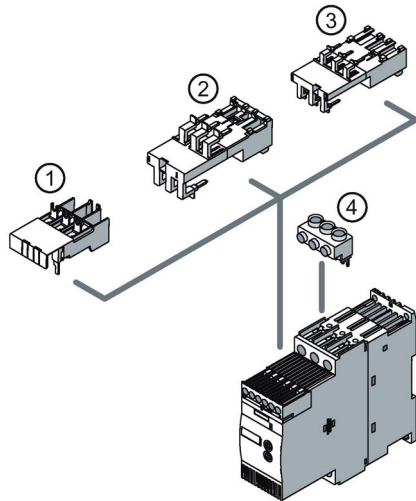

- 1 Link module to motor starter protector with screw-type terminals
- 2 Link module to motor starter protector with spring-loaded terminals (size S0)
- 3 Link module to motor starter protector with spring-loaded terminals (size S00)
- 4 Infeed terminal (sizes S00 and S0)

Figure 7-9 Accessories for 3RW30 soft starters

Accessories for 3RW40 soft starters

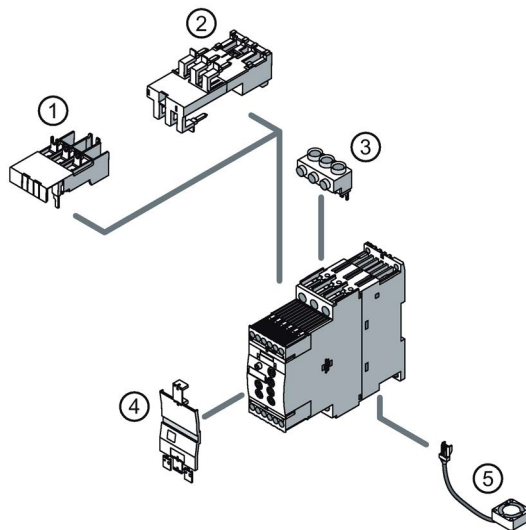

- 1 Link module to motor starter protector with screw-type terminals
- 2 Link module to motor starter protector with spring-loaded terminals
- 3 Infeed terminal
- 4 Sealing cover
- 5 Fan for increased switching frequency

Figure 7-10 Accessories for 3RW40 soft starters

Reference

More information ...	Is available in ...
about the 3RW soft starters	the chapter "Manuals - SIRIUS Modular System (Page 26)" in the "SIRIUS 3RW30/3RW40 Soft Starters" manual and the "SIRIUS 3RW44 Soft Starters" manual.

7.2 Protecting

7.2.1 SIRIUS 3RV motor starter protectors

3RV motor starter protectors



Figure 7-11 Motor starter protector S0

SIRIUS 3RV motor starter protectors can be combined with other SIRIUS devices easily and flexibly, while also saving on space and wiring:

Table 7-9 3RV motor starter protectors

Area	Customer benefits
Functions	<ul style="list-style-type: none"> • Short-circuit protection, overload protection, switching (manual), isolation • Enables fuseless design of load feeders • Motor protection, starter protection, system protection, and transformer protection • Fuse monitoring • Distance protection
Dimensioning and design	<ul style="list-style-type: none"> • S00 and S0 (up to 40 A in a width of only 45 mm) • S2 (up to 80 A in a width of only 55 mm) • S3 (up to 100 A in a width of only 70 mm) • Screw-type connection system (up to 100 A), spring-loaded connection system (3RV2 only, in sizes S00 and S0 up to 32 A), ring cable lug connection system (3RV2 only, in sizes S00 and S0 up to 32 A and S3)
Mounting advantages	<ul style="list-style-type: none"> • Can be combined easily and quickly with any SIRIUS switching device • Reduced main circuit wiring through combination with: <ul style="list-style-type: none"> – SIRIUS infeed system – 3-phase busbar system – 8US busbar system
Application areas/customer benefits	<ul style="list-style-type: none"> • Minimized space requirements • Reduced power consumption • Global applicability thanks to comprehensive approvals

7.2.1.1 Introduction

Applications

3RV motor starter protectors are compact current-limiting devices which have been optimized for load feeders. They are used for protecting and switching three-phase motors and other loads. The scalable setting ranges mean that a suitable motor starter protector can provide protection for all standard motors at ambient temperatures of ≤ 60 °C. 3RV1.11 motor starter protectors have a toggle switch. 3RV2 motor starter protectors are uniformly fitted with rotary operating mechanisms.

Functions

The motor starter protectors protect loads against overloads and short circuits. They also feature a lockable rotary operating mechanism / toggle switch to facilitate manual switching on and off (e.g. in the event of repair work).

System integration

In both electrical and mechanical terms the motor starter protectors are compatible with 3RT contactors, 3RF solid-state contactors, and 3RW soft starters. They can be integrated in the feeder by means of direct mounting. 3RV1 motor starter protectors are available in size S00. 3RV2 motor starter protectors are available in four sizes, S00, S0, S2 and S3.

Note

3RF solid-state contactors are available in two sizes, S00 and S0.

Connection systems

The motor starter protectors are available with the following connection system options (in the main circuit):

- Screw-type connection terminals (up to 100 A)
- Spring-loaded connection system (3RV2 only, in sizes S00 and S0 up to 32 A)
- Ring cable lug connection technology (3RV2 only, in sizes S00 and S0 up to 32 A, and S3)

Accessories

The accessories have been tailored to the motor starter protectors and they are available with a screw-type connection system, spring-loaded connection system or ring cable lug connection system. Accessories can be fitted easily and without the need for tools.

7.2.1.2 Versions

Device versions

- Motor starter protector standard version (3RV1011, 3RV20)
Overload and short-circuit protection
- Motor starter protectors with relay function (3RV21)
Short-circuit protection and auto-RESET in the event of overload in one device
- MSP for starter combinations (3RV23)
Short-circuit protection only
Combined with solid-state overload relay, large setting ranges and auto-RESET
- MSP for transformer protection (3RV24)
Standard version for transformers
- Circuit breakers in accordance with UL489 (3RV27/3RV28)
Overload protection, short-circuit protection, and transformer protection
- Circuit breaker for fuse monitoring (3RV1611-0BD10)
- Voltage transformer circuit breakers for distance protection (3RV1611-1.G14)

Sizes

3RV1 motor starter protectors are available in size S00 (45 mm width) up to a maximum rated current of 12 A. 3RV2 motor starter protectors are available in four sizes, S00, S0, S2 and S3.

The table below lists the sizes and the corresponding maximum rated current at a voltage of 400 V AC. The last column of the table indicates the maximum power of the three-phase motor which is suitable for the relevant size.

Table 7- 10 Size of the 3RV2 motor starter protector

Size	Width	Max. rated current	Power of three-phase motor
S00	45 mm ¹⁾	16 A	7.5 kW
S0	45 mm ¹⁾	40 A ²⁾	18.5 kW
S2	55 mm ³⁾	80 A	37 kW
S3	70 mm ⁴⁾	100 A	45 kW / 55 kW

1) 3RV211, 3RV212: 65 mm

2) 3RV20 and 3RV23 only

3) 3RV213: 75 mm

4) 3RV214: 90 mm

Number of poles

3RV motor starter protectors have 3 poles.

7.2.1.3 Applications

General

3RV motor starter protectors are used for protecting and switching the following loads:

- Three-phase motors up to 45 kW / 55 kW at 400 V AC
- Loads with rated currents up to 100 A

Special applications

The various 3RV motor starter protectors are suitable for:

- Short-circuit protection
- Motor protection (also with overload relay function)
- System protection
- Short-circuit protection for starter combinations
- Transformer protection
- As main and EMERGENCY OFF switches
- Use in IT systems
- Switching direct current (size S2 and S3 on request)
- Hazardous areas (ATEX)
- Use as Branch Circuit Protection Device (BCPD) according to UL (3RV27/28)
- Circuit breaker for fuse monitoring (3RV1611-0BD10)
- Use as voltage transformer circuit breakers for distance protection (3RV1611-1.G14)

7.2.1.4 Performance features

SIRIUS motor starter protectors boast the following technical advantages:

Technical highlights	Customer benefits
Up to 20 % less power consumption than previous solutions	<ul style="list-style-type: none"> Reduced temperature rise in the control cabinet Cost savings during operation
Uniform connection systems: <ul style="list-style-type: none"> Screw-type connection (sizes S00, S0, S2 and S3) Spring-loaded connection (size S00⁷⁾, S0, S2¹⁾ and S3¹⁾) Ring cable lug connection (size S00⁷⁾, S0, S2³⁾ and S3⁴⁾) 	The right connection for every application (e.g. operational reliability (vibration-resistant, non-temperature-specific, etc.) and less wiring thanks to spring-loaded connection system)
Link modules for any device combination from the SIRIUS modular system	Fast, error-free installation for screw-type connection system and spring-loaded connection system
<ul style="list-style-type: none"> Motor starter protectors up to 40 A (18.5 kW) in 45 mm width Motor starter protectors up to 80 A (37 kW) in 55 mm width Motor starter protectors up to 100 A (55 kW) in 70 mm width 	Space and cost savings
Motor starter protector combined with undervoltage release and contactor can be used as a Cat. 3 feeder in accordance with EN 951-1, SIL 2 in accordance with IEC 62061 or PL d 13849-1	Safety solution can be implemented with just one switching device
Factory-fitted integrated auxiliary switches (optional)	Reduced installation complexity
Joint range of accessories for sizes S00, S0, S2 and S3 ⁶⁾	Easy to configure, reduced stockkeeping
Current values graded in accordance with all standard motors	<ul style="list-style-type: none"> The right motor starter protector for every standard motor Integrated protection even for ambient temperatures > 60 °C (with derating)
Bimetals with extreme long-term stability	Operational reliability over many years
Compatible for use in all infeed systems (3-phase busbars ⁵⁾ , 3RA6 ²⁾ , 3RV29 infeed ²⁾ , 8US)	Maximum flexibility in terms of power infeed

1) In the case of size S2 and S3 devices, only connection of the auxiliary circuit is possible using spring-type terminals.

2) Only for devices of size S00 and S0.

3) In the case of size S2 devices, only connection of the auxiliary circuit is possible using ring cable lug connection technology.

4) On devices of size S3, the terminal blocks of the main current connectors can be removed and conductors with ring cable lugs can be connected.

5) Only for devices of size S00, S0 and S2.

6) Not applicable to 3RV1 motor starter protectors.

7) Not applicable to 3RV1 motor starter protectors.

7.2.1.5 Accessories for SIRIUS 3RV motor starter protectors

Accessories

For maximum flexibility, accessories can be added to the motor starter protector as required, easily, and without the need for tools.

Mountable accessories

The mountable accessories for size S00 3RV1011 motor starter protectors are illustrated below.

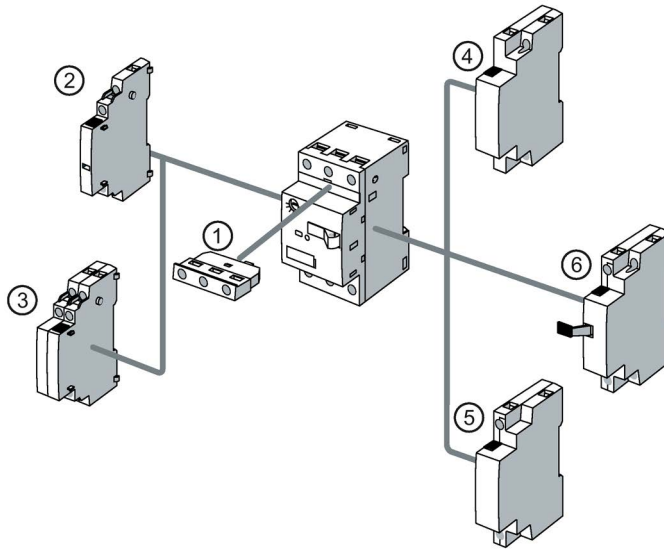

- ① Transverse auxiliary switch
- ② Lateral auxiliary switch with 2 contacts
- ③ Lateral auxiliary switch with 4 contacts
- ④ Shunt release
- ⑤ Undervoltage release
- ⑥ Undervoltage release with leading auxiliary contacts

The mountable accessories for size S00/S0 3RV2 motor starter protectors are illustrated below.

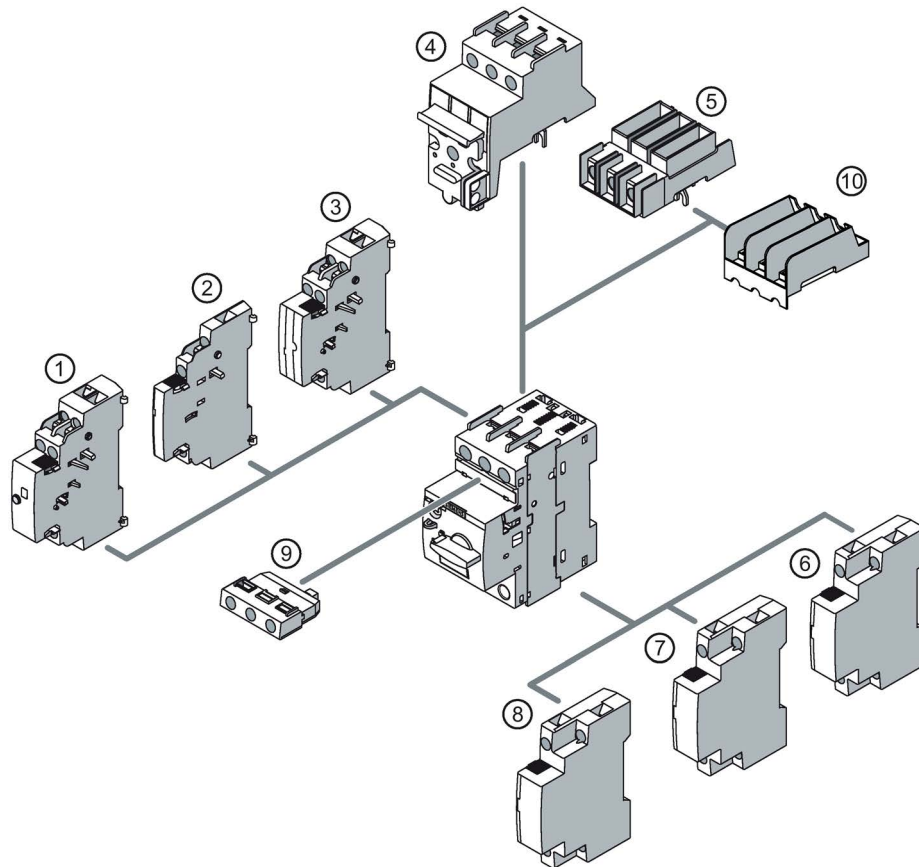

- ① Signaling switch
- ② Lateral auxiliary switch with 2 contacts
- ③ Lateral auxiliary switch with 4 contacts
- ④ Disconnecter module
- ⑤ Terminal block type E
- ⑥ Undervoltage release
- ⑦ Shunt release
- ⑧ Undervoltage release with leading auxiliary contacts
- ⑨ Transverse auxiliary switch
- ⑩ Phase barriers / accessories, type E

Figure 7-12 Motor starter protectors size S00 and S0 with mountable accessories

The mountable accessories for size S2 and S3 3RV2 motor starter protectors are illustrated below.

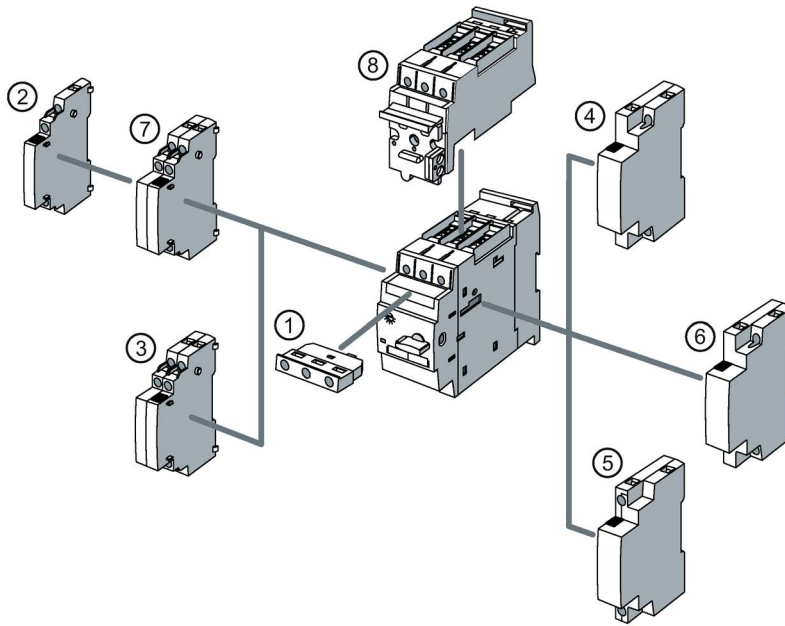

- ① Transverse auxiliary switch
- ② Lateral auxiliary switch with 2 contacts
- ③ Lateral auxiliary switch with 4 contacts
- ④ Shunt releases
- ⑤ Undervoltage releases
- ⑥ Undervoltage release with leading auxiliary contacts
- ⑦ Signaling switch
- ⑧ Isolator module (for size S2 only)

Figure 7-13 Motor starter protector size S2 and S3 with mountable accessories

Further accessories

- Phase barriers / accessories, type E
- Door-coupling rotary operating mechanism
- Enclosures and mounting accessories
- Sealable cover
- Insulated 3-phase busbar system
- 8US busbar adapter
- 3RV2917 infeed system (3RV2 only, in sizes S00 and S0)
- Link modules for the installation of contactors, solid-state contactors or soft starters
- Motorized remote operating mechanism (for 3RV2 motor starter protector, size S3 only)

Infeed systems

The SIRIUS modular system has the right infeed for every requirement.

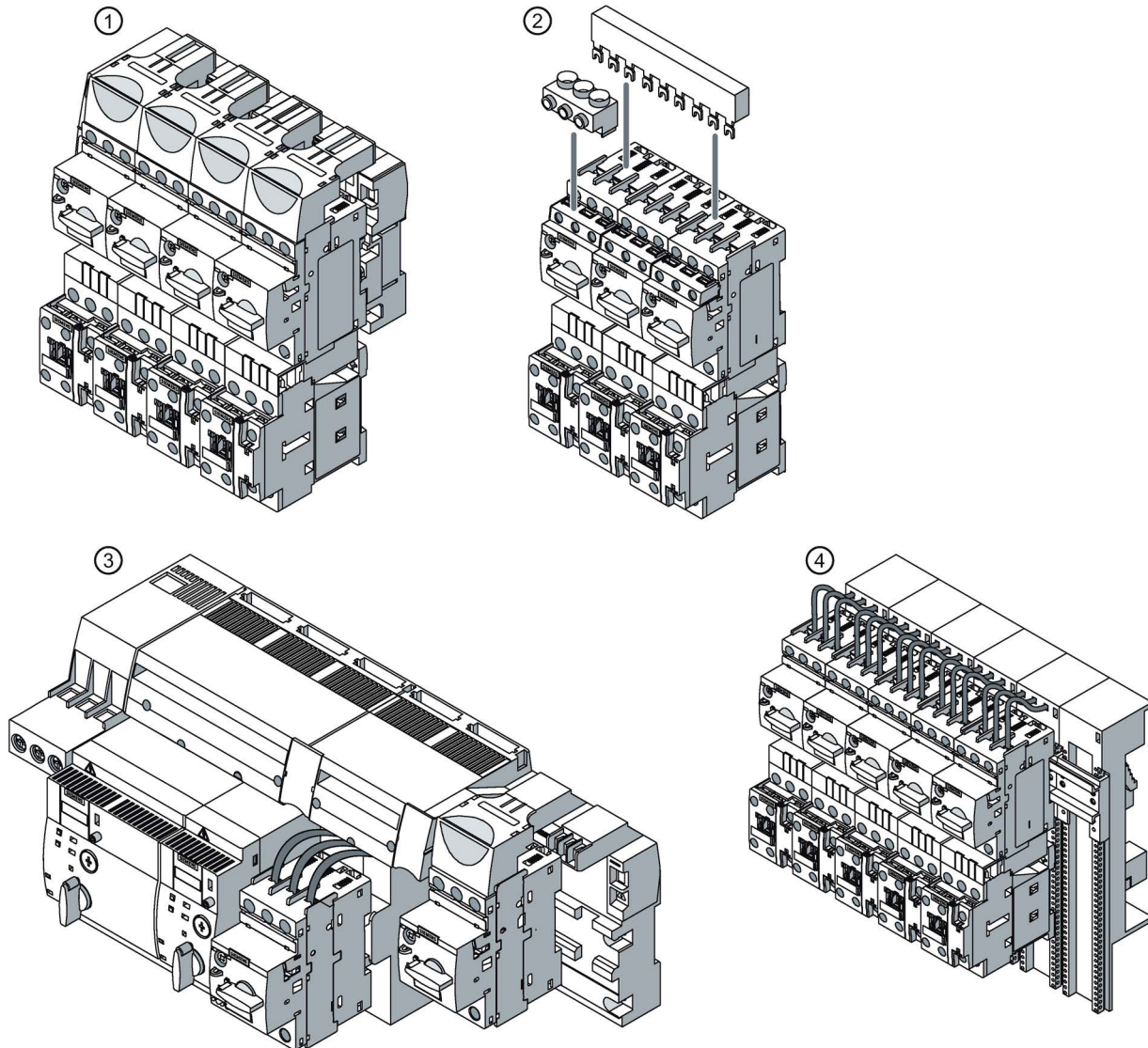

- 1 SIRIUS infeed system (3RV2917)
- 2 3-phase busbar system (3RV1915)
- 3 Combination of 3RA68 infeed system for compact starter and 3RV2917 infeed system for motor starter protector
- 4 Busbar system (8US)

Figure 7-14 Infeed systems

7.2.1.6 SIRIUS 3RV2917 infeed system

3RV2917 infeed system (for sizes S00 and S0)

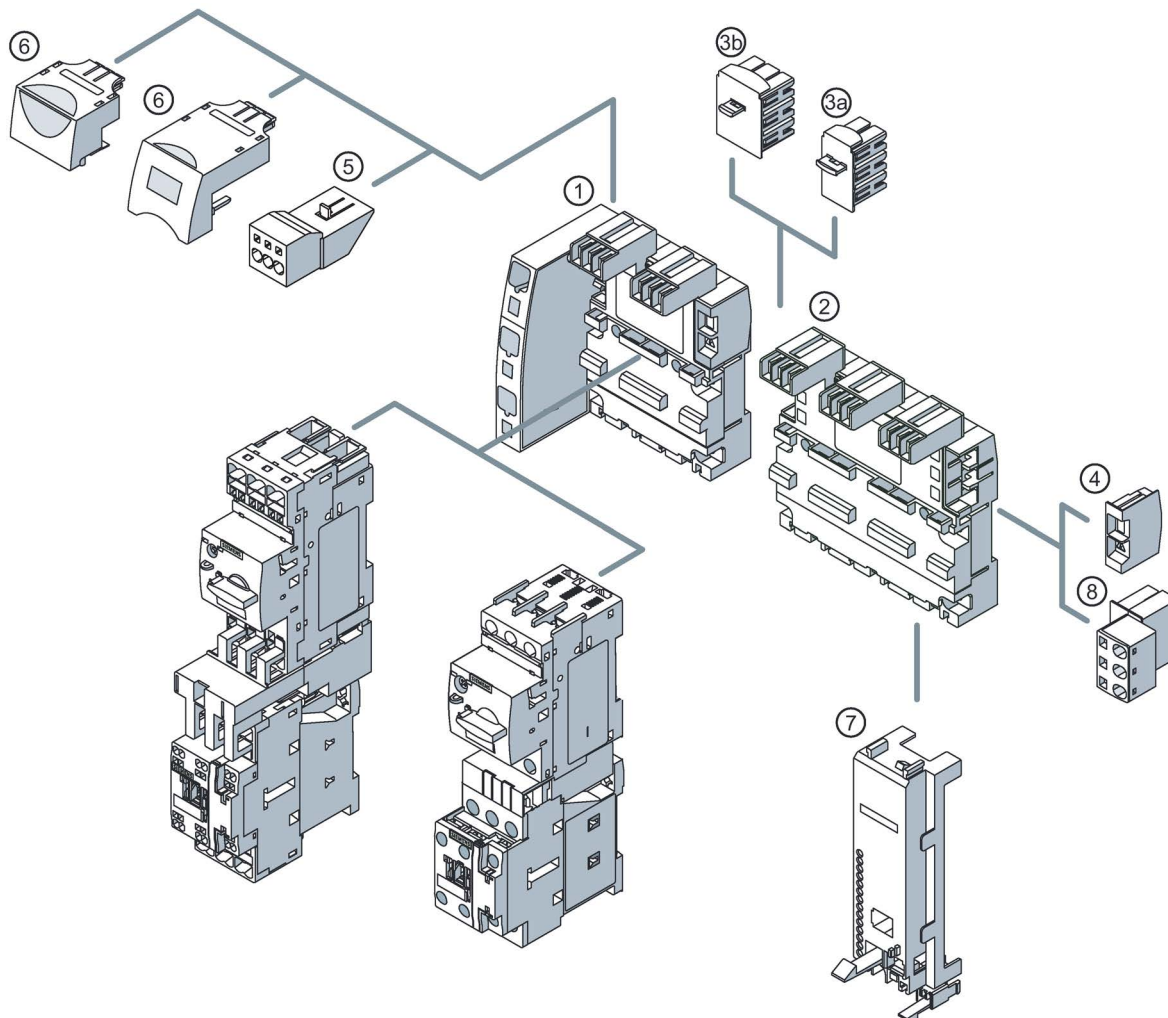

- 1 3-phase busbar with infeed (optionally on the left or right)
- 2 3-phase busbar for system expansion
- 3 Expansion plug
- 4 End cap
- 5 Connector
- 6 Contactor base
- 7 Outgoing terminal

Figure 7-15 3RV2917 infeed system

Reference

More information ...	Is available in ...
about the 3RV motor starter protectors	section "Manuals - SIRIUS Modular System (Page 26)" in the "SIRIUS - SIRIUS 3RV motor starter protectors" manual.

7.2.2 SIRIUS 3RU thermal overload relays / SIRIUS 3RB electronic overload relays

3RU thermal overload relays / 3RB electronic overload relays



Figure 7-16 S0 overload relay

The thermal and electronic overload relays are available in the modular system with graded functionality, which reflects their flexible applicability.

Table 7- 11 SIRIUS 3RU thermal overload relays / SIRIUS 3RB electronic overload relays

Area	Customer benefits
Functions	<p>3RU21 thermal overload relays:</p> <ul style="list-style-type: none"> • Tripping in the event of overload • Tripping due to phase unbalance • Tripping due to phase failure • Protection of single-phase loads <p>3RB30 / 3RB31 and 3RB20 / 3RB21 electronic overload relays:</p> <ul style="list-style-type: none"> • Tripping in the event of overload • Tripping due to phase unbalance • Tripping due to phase failure • Tripping in the event of a ground fault (can be activated by internal ground-fault detection)

Area	Customer benefits
Dimensioning and design	<ul style="list-style-type: none"> • 3RU21 performance ranges: <ul style="list-style-type: none"> – S00 (16 A) – S0 (38 A) – S2 (80 A) – S3 (100 A) • 3RB30 / 3RB31 performance ranges: <ul style="list-style-type: none"> – S00 (16 A) – S0 (38 A) – S2 (80 A) – S3 (115 A) • 3RB20 / 3RB21 performance ranges: <ul style="list-style-type: none"> – S6 (200 A) – S10 / S12 (630 A) • Width: <ul style="list-style-type: none"> – S00 / S0 (45 mm) – S2 (55 mm) – S3 (70 mm) – S6 (120 mm) – S10 / S12 (145 mm) • Large wide setting range of 1:4 with 3RB3 • High long-term stability through special bimetals with 3RU2 • Matched and uniform accessories for thermal and electronic overload relays • Screw-type connection system, spring-loaded connection system (sizes S2 and S3 auxiliary circuit only), ring cable lug connection system (3RU21 only: main circuit and auxiliary circuit in sizes S00 and S0; main circuit in size S3 only)
Mounting advantages	<ul style="list-style-type: none"> • Optional direct mounting on contactor or stand-alone assembly • Removable terminals for control circuit wiring (3RB3) • Same stand-alone assembly support for 3RU2 and 3RB3, with screw-type and spring-loaded connection systems
Application areas/customer benefits	<ul style="list-style-type: none"> • Optimum adjustability to the motor current: overlapping ranges up to 60°C, above that up to 70°C without overlapping • Comprehensive approvals for global applicability (e.g. ATEX)

7.2.2.1 Introduction

3RU21 thermal overload relays

3RU21 thermal overload relays up to 100 A have been designed to provide current-dependent protection for loads with normal starting against impermissibly high temperature rises due to overload, phase asymmetry or phase failure.

An overload or phase failure results in an increase of the motor current beyond the set rated motor current. Via heating elements, this current rise increasingly heats up the bimetal strips located inside the device. The deflection of these bimetal strips eventually activates the auxiliary contacts via a release mechanism. The contacts then disconnect the load via a contactor. (The contactor function is not an integral component of the overload relay).

3RB20 / 3RB21 and 3RB30 / 3RB31 electronic overload relays

3RB20 / 3RB21 electronic overload relays up to 630 A and 3RB30 / 3RB31 electronic overload relays up to 115 A with internal power supply have been designed to provide current-dependent protection for loads with normal starting and heavy starting against impermissibly high temperature rises due to overload, phase asymmetry or phase failure.

An overload, phase asymmetry or a phase failure results in an increase of the motor current beyond the set rated motor current.

This rise in current is detected by the current transformers integrated into the devices and evaluated by corresponding electronic circuits which then output a pulse to the auxiliary contacts. The contacts then disconnect the load via a contactor. (The contactor function is not an integral component of the overload relay).

In addition to current-dependent protection for loads against impermissibly high temperature rise caused by overload, phase asymmetry, and phase failure, 3RB21 and 3RB31 electronic overload relays feature internal ground-fault detection (not possible in conjunction with contactor assemblies for star-delta (wye-delta) start). This provides protection of loads against high-impedance faults to ground caused by damaged insulation, moisture, condensation, etc.

System integration

The overload relays have been matched to the contactors in the 3RT series both electrically and mechanically and can be integrated in the feeder by means of direct mounting. 3RU2 thermal overload relays are available in sizes S00 to S3 up to 100 A. 3RB30 and 3RB31 electronic overload relays are available in sizes S00 to S3 up to 115 A. 3RB20 and 3RB21 electronic overload relays are available in sizes S6 to S10 / S12 up to 630 A.

Connection systems

The overload relays are available with the following connection system options:

- Screw-type connection system
- Spring-loaded connection system (sizes S2 and S3 auxiliary circuit only)
- Ring cable lug connection technology (3RU21 only: main circuit and auxiliary circuit in sizes S00 and S0; main circuit in size S3 only)

3RB3 (sizes S2 and S3) and 3RB2 (size S6) electronic overload relays are also available in through-hole technology with straight-through transformer. As an alternative, 3RB20 / 3RB21 electronic overload relays in sizes S6 to S10 / S12 can be connected to the main circuit via busbars.

7.2.2.2 Versions

Sizes, setting ranges, and device versions

The table below provides an overview of the various sizes in which 3RU21 thermal overload relays and 3RB20 / 3RB21 and 3RB30 / 3RB31 electronic overload relays are available. The maximum rated currents, the minimum and maximum setting ranges, and the available tripping classes are listed for each individual size.

Table 7- 12 3RU21 thermal overload relays

Size	Width	Current range	Rated operating voltage U _e	Rated frequency	Trip class
S00	45 mm	0.11 to 16 A	690 V AC	50/60 Hz	CLASS 10
S0	45 mm	1.8 to 40 A			CLASS 10 or CLASS 10A
S2	55 mm	11 to 80 A			CLASS 10
S3	70 mm	28 ... 100 A	690 V AC		CLASS 10

Table 7- 13 3RB20 / 3RB30 electronic overload relays

Size	Width	Current range	Rated operating voltage U _e	Rated frequency	Trip class
S00	45 mm	0.1 to 16 A	690 V AC	50/60 Hz	CLASS 10E or 20E (fixed)
S0	45 mm	0.1 to 40 A			
S2	55 mm	12.5 to 80 A	690 V AC Through-hole technology: 1000 V AC		
S3	70 mm	12.5 ... 115 A	1000 V AC		
S6	120 mm	50 ... 200 A	690 V AC		
S10 / S12	145 mm	55 ... 250 A to 160 ... 630 A	690 V AC		

Table 7- 14 3RB21 / 3RB31 electronic overload relays

Size	Width	Current range	Rated operating voltage U _e	Rated frequency	Trip class
S00	45 mm	0.1 to 16 A	690 V AC	50/60 Hz	CLASS 5E, 10E, 20E, 30E (adjustable)
S0	45 mm	0.1 to 40 A			
S2	55 mm	12.5 to 80 A	690 V AC Through-hole technology: 1000 V AC		
S3	70 mm	12.5 ... 115 A	1000 V AC		
S6	120 mm	50 ... 200 A	690 V AC		
S10 / S12	145 mm	55 ... 250 A to 160 ... 630 A	690 V AC		

3RB30 / 3RB31 electronic overload relays have approximately the same dimensions as 3RU21 thermal overload relays. As a result, the thermal overload relays can be replaced easily with the electronic variant 3RB30/3RB31. This is necessary, for example, if increased overload protection is required (wide setting ranges (1:4), for example, or even reduced power loss and, as a result, minimized energy consumption).

7.2.2.3 Applications

Table 7- 15 Overview of applications

Applications	3RU21	3RB20 / 3RB21 3RB30 / 3RB31
System protection	✓ ¹⁾	✓ ¹⁾
Motor protection	✓	✓
Alternating current, 3-phase	✓	✓
Alternating current, 1-phase	✓	-
DC current	✓	-

1) In the main circuit, the devices provide overload protection for the assigned electrical loads (e.g. motors), feeder cable, and other switching and protection devices in the respective load feeder. The 3 phases have to be under symmetrical load.

3RU21 thermal overload relays

3RU21 thermal overload relays have been designed to protect three-phase loads, DC loads, and single-phase AC loads.

Note

Protection of DC loads/single-phase AC loads

If a 3RU21 thermal overload relay is to be used to protect DC loads or single-phase AC loads, all the bimetal strips have to be heated. Therefore, all of the relay's main current paths have to be connected in series.

3RB20 / 3RB21 and 3RB30 / 3RB31 electronic overload relays

3RB20 / 3RB21 and 3RB30 / 3RB31 electronic overload relays are designed to protect three-phase loads in sinusoidal 50/60 Hz voltage supplies.

Note

DC loads/Single-phase AC loads

The relay is not suitable for protecting DC loads or single-phase AC loads. On single-pole loads, the 3RU21 thermal overload relay or the 3RB22, 3RB23 and 3RB24 electronic overload relays for higher applications (no protection for DC loads) must be used for IO-Link.

The advantages of load feeders with overload relays

Installing load feeders with overload relays (fuses + contactor + overload relay or MSP for starter combinations/circuit breaker (acc. to UL) + contactor + overload relay) has the following advantages over configurations without overload relays (motor starter protector + contactor):

- Overload release and short-circuit release are signaled separately. In the event of a short circuit the fuses or the MSP for starter combinations/circuit breaker (acc. to UL) limit the short-circuit current and in the event of an overload the overload relay disconnects the contactor (and thus the load).
- The overload relays are especially suitable for use in fused switchgear assemblies. The devices are also used in applications in line networks with operating voltages of more than 400 V. Compared with fuseless design, the fuses still have an extremely high short-circuit breaking capacity in excess of 100 kA, even in these voltage ranges.
- Automatic RESET is easy to implement with the overload relays. Following an overload trip, the load feeder need not be switched on again on-site.
- Attachable electrical or mechanical RESET modules compatible for use with all sizes enable 3RU21 thermal overload relays to be RESET remotely. Mechanical RESET modules that are compatible for use with all sizes can also be attached to 3RB20 / 3RB21 und 3RB30 / 3RB31 electronic overload relays. An electrical remote RESET is an integral component of the 3RB21 / 3RB31.
- Applications with lengthy start times can be implemented thanks to the different trip classes of the 3RB20 / 3RB21 and 3RB30 / 3RB31 electronic overload relays.
- 3RB20 / 3RB21 and 3RB30 / 3RB31 electronic overload relays reduce variation and simplify configuring and inventory management thanks to their wide 1:4 setting range.
- MSP for starter combinations/circuit breaker (acc. to UL) + contactor + overload relay combinations have the advantage that the load feeder can be isolated easily and all three poles can be disconnected in the event of a short circuit.

Accessories for 3RU2 and 3RB30/31 overload relays

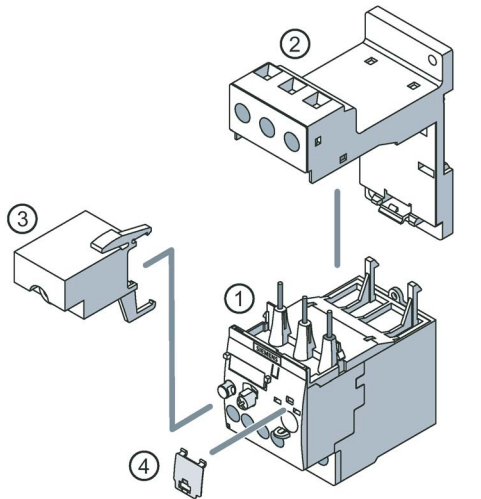

- 1 Overload relay size S0
- 2 Stand-alone assembly support
- 3 Electrical remote RESET (3RU2 only)
- 4 Sealing cover

Figure 7-17 Accessories for 3RU2 and 3RB30/31 overload relays

Reference

More information ...	Is available in ...
about the 3RU, 3RB overload relays	section "Manuals - SIRIUS Modular System (Page 26)" in the "SIRIUS - SIRIUS 3RU thermal overload relays / SIRIUS 3RB electronic overload relays" manual.

7.2.3 3RB24 electronic overload relays for IO-Link

3RB24 electronic overload relays for IO-Link



Figure 7-18 Electronic overload relay

Table 7- 16 SIRIUS 3RB24 electronic overload relays for IO-Link

Area	Customer benefits
Functions	3RB24 electronic overload relays for IO-Link: <ul style="list-style-type: none"> • Tripping in the event of overload • Tripping due to phase unbalance • Tripping due to phase failure • Tripping in the event of overheating (integrated thermistor motor protection function) • Tripping in the event of a ground fault (can be activated by internal ground-fault detection)
Dimensioning and design	<ul style="list-style-type: none"> • 3RB24 for IO-Link performance ranges and current ranges of the 3RB29.6 current measuring module: <ul style="list-style-type: none"> – S00 / S0 (25 A) – S2 / S3 (100 A) – S6 (200 A) – S10 (630 A) – S12 (630 A) • Width of the evaluation module: <ul style="list-style-type: none"> – 45 mm • 3RB24 for IO-Link: Screw-type connection system, spring-loaded connection system • 3RB29: <ul style="list-style-type: none"> – Up to size S6: Straight-through transformers – Sizes S6 and S10 / S12: Bus connection
Mounting advantages	<ul style="list-style-type: none"> • Modular device concept: <ul style="list-style-type: none"> – Evaluation module (independent of motor current) – Current measuring module (independent of motor current) – Connecting cable • Removable terminals
Application areas/customer benefits	<ul style="list-style-type: none"> • Protection of three-phase motors • Protection of induction motors • Protection of single-phase AC motors

7.2.3.1 Properties

Solid-state overload relay for IO-Link

The solid-state overload relay, comprising the 3RB24 evaluation module and a 3RB29 current measuring module, protects electrical equipment (e.g. three-phase motors) with two different protection mechanisms: overload protection and thermistor protection. Ground fault detection can also be enabled via IO-Link.

In conjunction with the 3RT contactors, the solid-state overload relay for IO-Link can be used as a direct-on-line starter, reversing starter or, with the help of an additional circuit, as a star-delta (wye-delta) starter. It is possible to read out diagnostics data, such as the current, via IO-Link and to further process this data in the higher-level controller.

7.2.3.2 System structure

Device concept

The 3RB24 solid-state overload relay has a modular device concept. Each device consists of a motor-current-independent evaluation module, and a motor-current-dependent current measuring module. Both modules are connected electrically to each other by connecting cable via the interface.

Optionally, the 3RA6935-0A operator panel can be connected to the front of the evaluation module.

Requirements

You require the following tools for system setup:

- 1 x evaluation module 3RB2483-4A .1
- 1 x current measuring module 3RB29.6-2...
- 1 x connecting cable 3RB2987-2.

Note

The connecting cable 3RB2987-2B for linking the evaluation module and the current measuring module is only to be used when the evaluation module is mounted direct on the current measuring module.

System structure

The following graphic illustrates the design principle of a system.

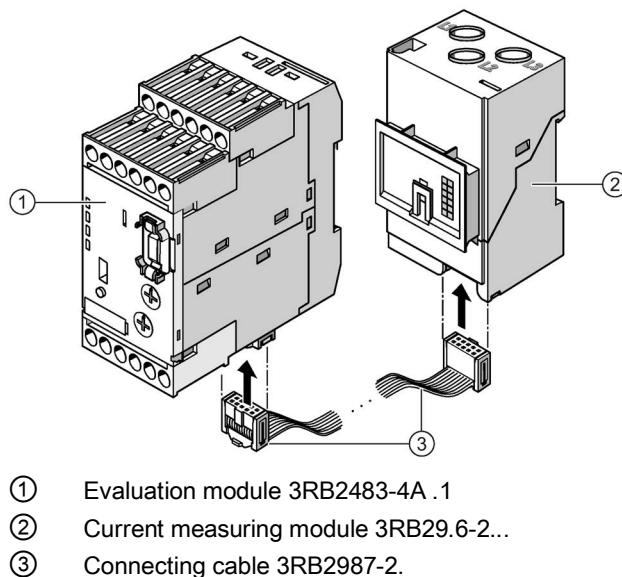

- ① Evaluation module 3RB2483-4A .1
- ② Current measuring module 3RB29.6-2...
- ③ Connecting cable 3RB2987-2.

Figure 7-19 System structure

7.2.3.3 Reference

Reference

More information ...	Is available in ...
about 3RB24 solid-state overload relay for IO-Link	the chapter "Manuals - SIRIUS Modular System (Page 26)" in the "3RB24 Solid-State Overload Relay for IO-Link" manual.

7.3 Monitoring

7.3.1 3UG4 / 3RR2 monitoring relays

7.3.1.1 SIRIUS 3RR2 current monitoring relays



Figure 7-20 S0 current monitoring relays

7.3 Monitoring

The SIRIUS 3RR2 current monitoring relays are ideally suited to a range of applications, thanks to the flexible way in which they can be adjusted:

Table 7- 17 3RR2 current monitoring relays

Area	Customer benefits
Functions	<ul style="list-style-type: none"> • Analog or digital setting • Versions available for IO-Link • Overcurrent and undercurrent monitoring • Phase sequence, phase failure, and fault current monitoring • Apparent or active current monitoring • Freely parameterizable threshold values and delay times • Manual and automatic reset
Dimensioning and design	<ul style="list-style-type: none"> • S00, S0, S2 (1.6 up to 80 A with only two versions) • 24 V AC/DC, 24 to 240 V AC/DC • 160 to 690 V wide voltage range in the main circuit • Width: <ul style="list-style-type: none"> – 45 mm (up to 40 A) – 55 mm (up to 80 A) • 1 CO contact and 1 semiconductor output • Clear status signals on the display • Screw-type and spring-loaded terminals
Mounting advantages	<ul style="list-style-type: none"> • Removable terminals for auxiliary circuit wiring • Direct mounting on contactor • Same stand-alone mounting support as with overload relays
Application areas/customer benefits	<ul style="list-style-type: none"> • One device for overload and underload monitoring • Integrated assembly: <ul style="list-style-type: none"> – Reduced wiring – No separate transformers required – 3-phase current monitoring with further monitoring options • Current monitoring relay for feeder-integrated load monitoring • Detection of fast and substantial, as well as slight and "subtle" changes

Product description

The tried and tested SIRIUS monitoring relays for electrical and mechanical quantities enable constant monitoring of all important characteristic quantities that provide information about the reliability performance of the plant. Sudden disturbances and gradual changes, which may reveal a maintenance requirement, for example, are both indicated. By means of relay outputs, the monitoring relays enable direct shutdown of the affected sections of the plant as well as issuing an alarm (e.g. by switching on a warning lamp). To respond flexibly to short-term disturbances such as voltage dips or load variation, the monitoring relays have settable delay times. This avoids unnecessary alarming and shutdowns while enhancing plant availability.

The individual 3UG4 monitoring relays offer the following functions in various combinations:

- Undershoot and/or overshoot of liquid levels
- Phase sequence
- Phase failure, neutral failure
- Phase asymmetry
- Undershoot and/or overshoot of voltage thresholds
- Undershoot and/or overshoot of current thresholds
- Undershoot and/or overshoot of power factor thresholds
- Monitoring of the active current or apparent current
- Monitoring of the fault current
- Monitoring the insulation resistance
- Undershoot and/or overshoot of speed thresholds

The 3RT2 contactors for mounting on 3RR2 current monitoring relays offer:

- Phase sequence
- Phase failure
- Undershoot and/or overshoot of current thresholds
- Monitoring of the active current or apparent current
- Monitoring of the fault current

Accessories for 3RR2 current monitoring relays

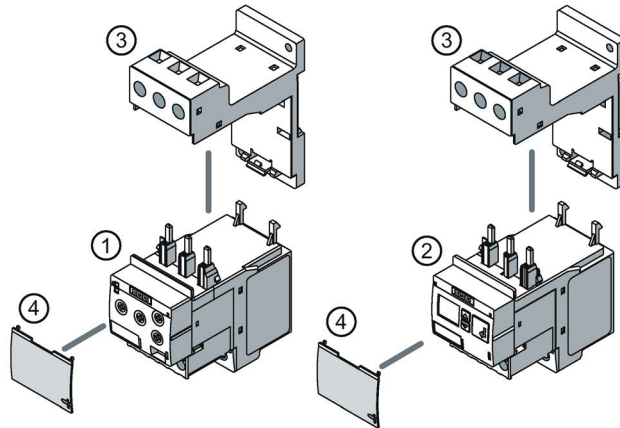

- 1 3RR21 current monitoring relays
- 2 3RR22 / 3RR24 current monitoring relays
- 3 Stand-alone assembly support
- 4 Sealing cover

Figure 7-21 3RR2 current monitoring relays

7.3.1.2 Overview of the functions

3RR2 current monitoring relays

Table 7- 18 Functions of the 3RR21 / 3RR22 current monitoring relays for analog and digital setting

Function	Current monitoring relay	
	3RR21	3RR22
Current monitoring		
Monitoring for undercurrent	2p	3p
Monitoring for overcurrent	2p	3p
Apparent current monitoring	✓	✓
Active current monitoring	—	✓
Range monitoring	2p	3p
Monitoring for phase failure, wire break	2p	3p
Monitoring for phase sequence	—	✓
Internal ground-fault detection (fault current monitoring)	—	✓
Blocking current monitoring	—	✓
Supply voltage		
Self-powered, without auxiliary voltage	—	—
Externally powered, with auxiliary voltage	✓	✓

✓: Function available

2p: Monitoring is 2-phase

3p: Monitoring is 3-phase

— : Function not available

3UG45 / 3UG46 monitoring relays

Table 7- 19 Functions of the 3UG45/3UG46 monitoring relays for analog and digital setting

Function	Monitoring relays																	
	3UG45					3UG46												
	01	11	12	13	8	14	15	16	17	18	31	32	33	21	22	41	25	51
Line monitoring and voltage monitoring																		
Monitoring for phase sequence	—	✓	✓	✓	—	✓	✓	✓	✓	✓	—	—	—	—	—	—	—	—
Monitoring for phase failure	—	o1)	✓	✓	—	✓	✓	✓	✓	✓	—	—	—	—	—	—	—	—
Monitoring for asymmetry	—	—	10 %	20 %	—	✓	o2)	o2)	✓	✓	—	—	—	—	—	—	—	—
Monitoring for undervoltage	—	—	—	3p	—	3p	3p	3p	3p	3p	1p	1p	1p	—	—	—	—	—
Monitoring for overvoltage	—	—	—	—	—	—	3p	3p	3p	3p	1p	1p	1p	—	—	—	—	—
Monitoring for neutral failure	—	—	—	—	—	—	—	✓	—	✓	—	—	—	—	—	—	—	—
Automatic direction of rotation correction in the case of incorrect phase sequence	—	—	—	—	—	—	—	—	✓	✓	—	—	—	—	—	—	—	—
Power factor monitoring and current monitoring																		
Monitoring for undercurrent	—	—	—	—	—	—	—	—	—	—	—	—	—	1p	1p	1p	—	—
Monitoring for overcurrent	—	—	—	—	—	—	—	—	—	—	—	—	—	1p	1p	1p	—	—
Active current monitoring	—	—	—	—	—	—	—	—	—	—	—	—	—	—	—	✓	—	—
Apparent current monitoring	—	—	—	—	—	—	—	—	—	—	—	—	—	✓	✓	—	—	—
Power factor monitoring	—	—	—	—	—	—	—	—	—	—	—	—	—	—	—	✓	—	—
Fault current monitoring/insulation monitoring																		
Monitoring for fault current/ground fault	—	—	—	—	—	—	—	—	—	—	—	—	—	—	—	—	✓	—
Insulation monitoring	—	—	—	—	✓	—	—	—	—	—	—	—	—	—	—	—	—	—
Filling level monitoring																		
Monitoring for filling level overshoot/resistance overshoot	✓	—	—	—	—	—	—	—	—	—	—	—	—	—	—	—	—	—
Monitoring for filling level undershoot/resistance undershoot	✓	—	—	—	—	—	—	—	—	—	—	—	—	—	—	—	—	—
Speed monitoring																		
Monitoring for speed overshoot	—	—	—	—	—	—	—	—	—	—	—	—	—	—	—	—	—	✓
Monitoring for speed undershoot	—	—	—	—	—	—	—	—	—	—	—	—	—	—	—	—	—	✓

Function	Monitoring relays																		
	3UG45					3UG46													
	01	11	12	13	8	14	15	16	17	18	31	32	33	21	22	41	25	51	
Rated control supply voltage																			
Self-powered, without auxiliary voltage	—	✓	✓	✓	—	✓	✓	✓	✓	✓	—	—	✓	—	—	✓	—	—	
Externally powered, with auxiliary voltage	✓	—	—	—	✓	—	—	—	—	—	✓	✓	—	✓	✓	—	✓	✓	

✓: Function available

1p: Monitoring is 1-phase

3p: Monitoring is 3-phase

— : Function not available

○: Function available with limitations

1) Detection causes problems with regenerative power recovery.

2) By monitoring the voltage thresholds.

7.3.1.3 Reference

Reference

More information ...	Is available in ...
about the 3UG4/3RR2 monitoring relays	the chapter "Manuals - SIRIUS Modular System (Page 26)" of the "3UG4/3RR2 Monitoring Relays" manual.

7.3.2 3RS1 / 3RS2 temperature monitoring relays

7.3.2.1 Product description

Product description

The temperature monitoring relays are used for measuring temperatures in solid, liquid, and gaseous media. The temperature is sensed by the sensors in the medium and evaluated by the device. It is monitored for overshoot, undershoot or, on digital device versions, remaining within a working range (range function).

The family comprises the following devices:

- Devices for analog setting, with one or two limit values
- Digital devices for 1 sensor (e.g. alternative to temperature controllers for low-end applications)
- Digital devices for up to 3 sensors (optimized for monitoring large motors)

7.3.2.2 Overview of the functions (3RS10/ 11/ 20/ 21)

Function

Table 7- 20 Functions of the 3RS1 / 3RS2 temperature monitoring relays

Function	Temperature monitoring relays															
	3RS10							3RS20 ²⁾		3RS11						3RS21 ²⁾
	00	10	20	30	40	41	42	40	41	00	01	20	21	40	42	40
Settings	a	a	a	a	d	d	d	d	d	a	a	a	a	d	d	d
Connectable sensor type																
Resistance sensors	✓	✓	✓	✓	✓	✓	✓	✓	✓	--	--	--	--	--	--	--
Thermocouple	--	--	--	--	--	--	--	--	--	✓	✓	✓	✓	✓	✓	✓
Number of sensors that can be monitored	1	1	1	1	1	3	1	1	3	1	1	1	1	1	1	1
Temperature monitoring																
Temperature monitoring for overshoot	✓	--	✓	--	✓	✓	✓	✓	✓	✓	✓	✓	✓	✓	✓	✓
Temperature monitoring for undershoot	--	✓	--	✓	✓	✓	✓	✓	✓	--	--	--	--	✓	✓	✓
Number of limit values that can be set ¹⁾	1	1	2	2	2	2	2	2	2	1	1	2	2	2	2	2

1) The device versions with two limit values can be switched between the open-circuit principle NO and the closed-circuit principle NC.

2) Temperature scale of the sensors in degrees Fahrenheit [°F].

✓: Function available

--: Function not available

a : Analog setting

d: Digital setting

Reference

More information ...	Is available in ...
about the 3RS1/3RS2 temperature monitoring relays	the chapter "Manuals - SIRIUS Modular System (Page 26)" in the "3RS1/3RS2 Temperature Monitoring Relays" manual.

7.3.3 3UG48 / 3RR24 monitoring relays for IO-Link

7.3.3.1 Product description

Product description

The tried and tested SIRIUS monitoring relays for electrical and mechanical quantities enable constant monitoring of all important characteristic quantities that provide information about the reliability performance of the plant. Sudden disturbances and gradual changes, which may reveal a maintenance requirement, for example, are both indicated. Through relay outputs, the monitoring relays enable direct shutdown of the affected sections of the plant as well as alarming (e.g. by switching a warning lamp). To respond flexibly to short-term disturbances such as voltage dips or load variation, the monitoring relays have settable delay times. This avoids unnecessary alarming and shutdowns while enhancing plant availability.

The individual monitoring relays provide the following functions in different combinations:

- Phase sequence
- Phase failure, neutral failure
- Phase asymmetry
- Voltage below and / or above thresholds
- Current below and / or above thresholds
- Power factor below and / or above thresholds
- Monitoring of the active current or apparent current
- Speed below and / or above thresholds

The SIRIUS 3UG48/3RR24 monitoring relays for IO-Link offer many other performance features in addition to monitoring functions:

- Measured values (including resolution and unit) to the higher-level control. Some device versions allow you to set which value is to be transferred cyclically.
- Transmission of alarm flags to the higher-level control.
- Comprehensive diagnostics capability by querying the precise cause of the error in the diagnostic data record.
- Remote parameterization additionally possible (supplementing local parameterization or instead of local parameterization).
- Fast parameterization of identical devices by duplicating the parameter assignment in the higher-level control.
- Parameter transfer by means of Upload to the higher-level control via- IO-Link call or by parameter server¹⁾ when using an IO-Link master in IO-Link Communication Specification V1.1 or higher).
- Local parameter assignment can be disabled via IO-Link.
- To prevent automatic startup after a power failure and to avoid losing diagnostic data, errors can be configured so that they are saved to non-volatile memory.
- Linking to a higher-level control makes it possible to assign parameters to the monitoring relays via a display unit. The measured values can be displayed directly in a control room or at the machine/control cabinet.

Up until now, using redundant sensors and/or analog signal converters to transfer measured values to a higher-level control incurred significant additional expense and wiring effort. Combining the autonomous monitoring relays with IO-Link communication reduces this wiring outlay and cuts costs.

As the availability of up-to-date measured values means that the higher-level control can take care of the control tasks within the plant, the continued availability of the output relays on the monitoring relays increases the plant's operational reliability (e.g. by shutting down the plant if thresholds that cannot be achieved under normal operating conditions are overshoot).

The monitoring relays continue to function autonomously in spite of the IO-Link connection. Parameters can be assigned locally at the device, independently of a higher-level control. As long as the 24 VDC supply voltage is available, the monitoring relays will function if the controller fails or is not yet available. If the 3UG48/3RR24 monitoring relay is used for IO-Link without a connection to a higher-level control, because of the integrated SIO-Mode, the devices feature an additional semiconductor output that switches when settable warning thresholds are exceeded.

¹⁾ The parameter server provides an assurance of consistent central data management in the event of changes to parameters (made locally or via the control). The "Parameter server" function supports the automatic backup of parameter data (automatic re-assignment of parameter data if a device is replaced).

7.3.3.2 Overview of the functions

3RR24 current monitoring relays for IO-Link

Table 7- 21 Functions of the digitally adjustable 3RR24 current monitoring relays for IO-Link

	Current monitoring relay
	3RR24
Current monitoring	
Monitoring for undercurrent	3p
Monitoring for overcurrent	3p
Range monitoring	3p
Apparent current monitoring	✓
Active current monitoring	✓
Monitoring for phase failure, wire break	3p
Monitoring for phase sequence	✓
Monitoring for current asymmetry	✓
Internal ground-fault detection (fault current monitoring)	✓
Blocking current monitoring	✓
Supply voltage	
External power supply (via the IO-Link master or an external 24 V DC voltage source)	✓
Additional functions	
Runtime meter	✓
Switching cycle counter	✓
Voltage measurement	1p
Cos phi calculation	✓
Runtime meter	✓
Switching cycle counter	✓
Voltage measurement	1p
Cos phi calculation	✓
Apparent power calculation	3p
Active power calculation	3p

✓: Function available

1p: Measuring is single-phase

3p: Monitoring/calculation is 3-phase

3UG48 monitoring relays for IO-Link

Table 7- 22 Functions of the 3UG48 monitoring relays for IO-Link

	3UG48 monitoring relays					
	15	16	32	22	41	51
Line monitoring and voltage monitoring						
Monitoring for phase sequence	✓	✓	—	—	—	—
Monitoring for phase failure	✓	✓	—	—	—	—
Monitoring for asymmetry	✓	✓	—	—	—	—
Monitoring for undervoltage	3p	3p	1p	—	—	—
Monitoring for overvoltage	3p	3p	1p	—	—	—
Monitoring for N-conductor failure	—	✓	—	—	—	—
Cos phi monitoring and current monitoring						
Monitoring for undercurrent	—	—	—	1p	1p	—
Monitoring for overcurrent	—	—	—	1p	1p	—
Active current monitoring	—	—	—	—	1p	—
Apparent current monitoring	—	—	—	1p	—	—
Monitoring for cos phi	—	—	—	—	1p	—
Speed monitoring						
Monitoring for speed overshoot	—	—	—	—	—	✓
Monitoring for speed undershoot	—	—	—	—	—	✓
Power supply						
External power supply (via the IO-Link master or an external 24 V DC voltage source)	✓	✓	✓	✓	✓	✓

✓: Function available

1p: Monitoring is single-phase

3p: Monitoring is 3-phase

— : Function not available

7.3.3.3 Reference

Reference

More information ...	Is available in ...
about the 3UG48 monitoring relays for IO-Link	the chapter "Manuals - SIRIUS Modular System (Page 26)" of the "3UG48 Monitoring Relays" manual.

7.3.4 3RS14 / 3RS15 temperature monitoring relays for IO-Link

7.3.4.1 Product description

Product description

The new SIRIUS 3RS14/3RS15 temperature monitoring relays for IO-Link are used to measure temperatures in solid, liquid, and gaseous media. The temperature is sensed by the sensors in the medium and evaluated by the device. Up to 2 limit values for overshoot, undershoot, or staying within a working range (range function) are monitored. In addition to providing warning and shutdown functions in the event of temperature deviations, the devices can be used as temperature controllers (single-step control, two-step control, or three-step control).

The devices differ in terms of the type and number of temperature sensors that can be connected to them:

- 3RS14: Connection for 1 or up to 3 resistance sensors
- 3RS15: Connection for 1 thermocouple

The 3RS14/3RS15 temperature monitoring relays for IO-Link offer many other performance features in addition to monitoring functions:

- Transmission of measured values (including resolution and unit) to the higher-level control.
Local display and transmission of the temperature unit (°C or °F) can be parameterized. The temperature measured value transferred from temperature monitoring relays with more than one resistance sensor can be adjusted. Some device versions allow you to set which value is transferred cyclically.
- Transfer of alarm flags to the higher-level control.
- Comprehensive diagnostics capability by querying the precise cause of the error in the diagnostic data record.
- Remote parameterization is also possible (instead of local parameter assignment).
- Fast parameterization of identical devices by duplicating the parameter assignment in the higher-level control.
- Parameter transfer by means of Upload to the higher-level control via- IO-Link call or by parameter server¹⁾ when using an IO-Link master in IO-Link Communication Specification V1.1 or higher).
- Local parameter assignment can be disabled via IO-Link.
- To prevent automatic startup after a power failure and in order not to lose diagnostic data, errors can be configured so that they are saved to non-volatile memory.
- Linking to a higher-level control makes it possible to assign parameters to the monitoring relays via a display unit. The measured values can be displayed directly in a control room or at the machine/control cabinet.

¹⁾ The parameter server provides an assurance of consistent central data management in the event of changes to parameters (made locally or via the control). The "Parameter server" function supports the automatic backup of parameter data (automatic re-assignment of parameter data if a device is replaced).

Up until now, using redundant sensors and/or analog signal converters to transfer measured values to a higher-level control incurred significant additional expense and wiring effort. Combining the autonomous monitoring relays with IO-Link communication reduces this wiring outlay and cuts costs.

As the availability of up-to-date measured values means that the higher-level control can take care of the control tasks within the plant, the continued availability of the output relays on the monitoring relays increases the plant's operational reliability (e.g. by shutting down the plant if limit values that cannot be achieved under normal operating conditions are overshoot).

The monitoring relays continue to function autonomously in spite of the IO-Link connection. Parameters can be assigned locally at the device, independently of a higher-level control. As long as the 24 VDC power supply is available, the monitoring relays will function should the controller fail or not yet be available.

7.3.4.2 Overview of the functions

Function

Table 7- 23 Functions of the temperature monitoring relays for IO-Link

Function	Temperature monitoring relays		
	3RS14		3RS15
	40	41	40
Connectable sensor type			
Resistance sensors	✓	✓	--
Thermocouple	--	--	✓
Number of sensors that can be monitored	1	3	1
Temperature monitoring			
Temperature monitoring for overshoot	✓	✓	✓
Temperature monitoring for undershoot	✓	✓	✓
Number of limit values that can be set ¹⁾	2	2	2

1) It is possible to switch between the open-circuit principle NO and the closed-circuit principle NC.

✓: Function available

--: Function not available

Reference

More information ...	Is available in ...
3RS14/3RS15 temperature monitoring relays for IO-Link	the chapter "Manuals - SIRIUS Modular System (Page 26)" of the "3RS14/3RS15 Temperature Monitoring Relays for IO-Link" manual.

7.4 Feeders and tested switchgear assemblies

7.4.1 SIRIUS 3RA load feeders

7.4.1.1 Overview

Fuseless load feeders

Fuseless load feeders are device combinations comprising a 3RV motor starter protector for overload and short-circuit protection and a 3RT contactor for normal switching. The SIRIUS portfolio features two different configuration options for fuseless load feeders.

- 3RA2 tested pre-assembled complete devices (sizes S00 to S2 only)
- Tested combinations of individual devices

7.4.1.2 Device versions

The modular standard components in the SIRIUS modular system are ideally matched and support the simple configuration of fuseless load feeders. The load feeders are also available as 3RA2 complete devices.

Both options are characterized by the following features.

- Type of coordination 1 or 2
- Rated control supply voltage
- Mounting on busbar or DIN rail
- Screw or spring-loaded connection

A detailed overview of the fuseless load feeders product range appears below.

Types of coordination

Fuseless load feeders up to 38 A (discrete configuration of individual devices with connecting cables) and 32 A (pre-assembled complete devices or configuration with link module) can be assembled in sizes S00 and S0.

An assembly up to 80 A (discrete configuration of individual devices with connecting cables) and 65 A (as pre-assembled complete devices, or configuration with link module) is possible in size S2.

An assembly up to 100 A (discrete configuration of individual devices with connecting cables) is possible in size S3.

The table below lists the maximum power of the three-phase motor for pre-assembled 3RA2 complete devices based on the type of coordination at a voltage of 400 V AC.

Table 7- 24 Motor starter protector sizes

Size	Type of coordination	Power of three-phase motor
S00	1	0.06 to 7.5 kW
	2	0.06 to 1.5 kW
S0	1	7.5 to 15 kW
	2	1.5 to 15 kW
S2	1	15 kW ... 30 / 37 kW (max. 65 A)
	2	15 kW ... 30 / 37 kW (max. 65 A)

Types of coordination

Standard DIN EN 60947-4-1 (VDE 0660 Part 102) or IEC 60947-4-1 distinguishes between two types of coordination (type of coordination), which are referred to as coordination type "1" and coordination type "2". In the case of both types of coordination, the short-circuit is reliably mastered. the only differences are in the extent of the damage sustained by the device following a short circuit.

Type of coordination 1

The load feeder may be non-operational after a short circuit has been cleared. Damage to the contactor and the overload release is also permissible.

Type of coordination 2

After short-circuit disconnection, there must be no damage to the overload release or to any other part. The load feeder can resume operation without needing to be renewed. Welding of the contactor contacts only is permitted if these can be separated easily without significant deformation.

Auxiliary contacts

The following auxiliary contacts are integrated into fuseless load feeders dependent upon size.

Table 7- 25 Integrated auxiliary contacts

Size	Direct feeder	Reversing feeder
S00	1 NO contact is integrated in the contactor.	1 NC contact is integrated in the contactor.
S0	1 NO contact and 1 NC contact are integrated in the contactor. The user can decide how the NC contact is assigned.	1 NO contact and 1 NC contact are integrated in the contactor. The NC contact is assigned to the interlock.
S2		
S3		

Assembly/Installation

The devices are prepared for DIN rail mounting, for mounting on a 60 mm busbar or for mounting on a base plate.

Table 7- 26 Mounting options

Starter combination		Direct-on-line starter				Reversing starter			
Size		S00	S0	S2	S3	S00	S0	S2	S3
Mounting on a standard rail									
	Snap-on mounting without adapter	✓ ¹⁾	✓ ¹⁾	✓ ²⁾	—	✓ ¹⁾	—	✓ ²⁾	—
	With DIN rail adapter	✓ ³⁾	✓ ³⁾	✓ ²⁾	✓ ²⁾	✓ ³⁾	✓ ³⁾	✓ ²⁾	✓ ²⁾
Mounting on 8US busbar									
	With 8US busbar adapter	✓	✓	✓	—	✓	✓	✓	—
Mounting on base plate									
	Direct	✓	✓	✓	—	✓	✓	✓	—
	With DIN rail adapter	✓	✓	✓	✓	✓	✓	✓	✓

- 1) Mounting on 1 DIN rail
- 2) Mounting on 2 DIN rails
- 3) Mounting on 1 or 2 DIN rails

7.4.1.3 SIRIUS 3RA21/22 load feeders



Figure 7-22 S0 load feeder

The tested load feeders offer switching and protection functions. Thanks to their multiple combination options, they can be easily configured for almost any requirement.

Table 7- 27 Load feeders

Area	Customer benefits
Functions	<ul style="list-style-type: none"> • Switching and protection functions in one mechanical unit • High short-circuit breaking capacity • Tested combinations (fuseless and fused) • Coordination types 1 and 2 (tested up to 150 kA) • Tested for CLASS 10, 20, 30 • With motor starter protectors or MSPs for starter combinations • With contactor, solid-state contactor, and soft starter • Connection to the automation level via IO-Link and AS-i
Dimensioning and design	<ul style="list-style-type: none"> • Tested for all common line voltages • S00, S0, S2 (0.06 up to 37 kW) • Pre-assembled SIRIUS 3RA2 feeders with 230 V AC and 24 V DC
Mounting advantages	<ul style="list-style-type: none"> • Easy mounting of individual components into tested combinations • Direct connection of switching devices • Perfectly matched accessories • Screw-type, spring-loaded, ring cable lug connection systems
Application areas/customer benefits	<ul style="list-style-type: none"> • Completely pre-assembled load feeders • Comprehensive type tests for load feeders for self-assembly by the customer (approx. 45000 combinations) • Comprehensive approvals for global applicability • Comprehensive dimensioning, planning, and construction support

7.4.1.4 SIRIUS 3RA21/22 pre-assembled load feeders

3RA21/22 pre-assembled load feeders

3RA21 / 3RA22 fuseless load feeders are pre-assembled complete devices; they are delivered ready-wired and with all mechanical connections established. The devices are available in sizes S00, S0 and S2 for direct-on-line start. Pre-assembled complete devices in sizes S00 and S0 are available for reversing start.

Sizes S00 and S0 are both available with either screw-type or spring-loaded connection systems. Size S2 is available with screw-type connection system.

The fuseless load feeders can be ordered with or without pre-assembled busbar adapters for mounting on a DIN rail or busbar.

Accessories for load feeders

The main accessories for 3RV2 motor starter protectors, and those for 3RT2 contactors (such as side-mounted and transverse auxiliary switches, current limiters, undervoltage limiters, rotary operating mechanisms, busbar adapters, etc.) can be used for 3RA21/22 load feeders and feeders for self-assembly.

7.4.1.5 Self-assembled load feeders

Assembly of load feeders from individual devices

Self-assembly load feeders comprising individual devices are available as an alternative to the 3RA2 complete device. In the case of a discrete configuration of individual devices without a link module, the values of the basic devices apply. The following components can be combined via the intermediary of a link module.

Combination	S00	S0	S2	S3
Motor starter protector and contactor	7.5 kW (16 A)	15 kW (32 A)	30 / 37 kW (65 A)	55 kW (100 A) ¹⁾
Motor starter protector and soft starter	7.5 kW (16 A)	15 kW (32 A)	30 / 37 kW (65 A) ¹⁾	On request
Motor starter protector and solid-state contactor	—	7.5 kW (16 A)	—	—

¹⁾ A DIN rail adapter shall be used for this combination

The modularity of the SIRIUS system means that the standard devices are perfectly matched from both a mechanical and an electrical point of view. As a straightforward means of assembling starter combinations, wiring kits are available for contactor assemblies for reversing and star-delta (wye-delta) start for size S2 / S3 with screw terminals, and for size S00 / S0 with various connection systems. Assembly kits are available for mounting self-assembled load feeders on DIN rails or busbars.

Assembly of three-part combinations with link module between the motor starter protector and the contactor

You are basically advised to refrain from setting up combinations of a motor starter protector, a contactor and an overload relay or a monitoring relay as a completely assembled three-part combination. If this should nevertheless be necessary, the following restrictions apply:

Motor starter protector + contactor + electronic overload relay / 3RR monitoring relay (size S00 / S0)

Thermal restrictions	Mechanical restrictions
No restrictions	DIN rail adapter required

Motor starter protector + contactor + electronic overload relay / 3RR monitoring relay (size S2)

Thermal restrictions	Mechanical restrictions
<ul style="list-style-type: none"> At an ambient temperature of $T_a = 40\text{ °C}$ (no restrictions) At an ambient temperature of $T_a = 60\text{ °C}$ (clearance between the load feeders: $\geq 10\text{ mm}$) 	No restrictions

Motor starter protector + contactor + solid-state overload relay (size S3)

Thermal restrictions	Mechanical restrictions
On request	On request

Motor starter protector + contactor + thermal overload relay (size S00 / S0)

Thermal restrictions:	Mechanical restrictions
Reduce permissible ambient temperature by 20 K	DIN rail adapter required
No side-by-side mounting ($\geq 10\text{ mm}$ clearance for vertical installation, $> 20\text{ mm}$ for horizontal installation)	
Current derating to 87 % of I_n	

Motor starter protector + contactor + thermal overload relay (size S2 / S3)

Note

A three-part combination consisting of a motor starter protector, a contactor and a thermal overload relay is not permissible for sizes S2 and S3.

7.4.1.6 Applications

Fuseless load feeders can be used anywhere in industry where fuse, contactor, and overload relay combinations were previously used. The increased functionality of the motor starter protector (unlike a fuse combination, it can be used as an EMERGENCY OFF and as a disconnect) means that a fuseless load feeder is capable of solving numerous applications easily.

Reference

More information ...	Is available in ...
about 3RA load feeders	section "Manuals - SIRIUS Modular System (Page 26)" in the "SIRIUS - SIRIUS 3RA load feeders" manual.

7.4.2 Device combinations

The flexible designs enable the individual devices to be combined in myriad different ways. More than 45000 combinations have been tested, which offer solutions for almost every application. Over 500 pre-assembled combinations are available, facilitating rapid and fault-free control cabinet assembly.

Device combinations

The combination matrix below shows which devices can be combined for the main circuit:

		Switching and starting			Protecting			Monitoring
		3RT2	3RF34	3RW30/40	3RV2	3RU2	3RB30/31	3RR2
Contactors	3RT2		—	—	X S	X S O	X S	X S
Solid-state switching devices	3RF34	—		—	X	—	X	X
Soft starters	3RW30/40	—	—		X S	—	—	—
Motor starter protectors	3RV2	X S	X	X S		—	—	—
Overload relays	3RU2	X S O	—	—	—			—
	3RB30/31	X S	X	—	—			—
Current monitoring relays	3RR2	X S	X	—	—	—		

- x Screw-type connection system
- s Spring-loaded connection system (size S00 / S0 only)
- o Ring cable lug connection system (size S00 / S0 only)
- Mechanical connection with link module
- Direct mechanical connection

Figure 7-23 Device combinations

Link modules

Link modules can be used to easily assemble feeders from individual devices. The table below shows the different combination options for devices with screw-type and spring-loaded connection systems:

Combination device	3RV2 motor starter protectors	3RT2 contactors; 3RW30, 3RW40 soft starters; 3RF34 solid-state contactors	Link modules	
			3RV2 motor starter protectors with screw-type terminals	3RV2 motor starter protectors with spring-loaded terminals
	Size	Size		
Link modules for connection of switching devices to 3RV2 motor starter protectors ¹⁾				
3RT2 contactors with AC or DC coil	S00	S00	3RA1921-1DA00	3RA2911-2AA00
3RT2 contactors with AC coil	S0	S0	3RA2921-1AA00	3RA2921-2AA00
3RT2 contactors with DC coil	S0	S0	3RA2921-1BA00	3RA2921-2AA00
3RT2 contactors with AC coil or AC / DC coil	S2	S2	3RA2931-1AA00	—
3RT2 contactors with AC coil or AC / DC coil	S3	S3	3RA1941-1AA00	—
3RW30 soft starters	S00	S00	3RA2921-1BA00	3RA2911-2GA00
3RW30/3RW40 soft starters	S0	S0	3RA2921-1BA00	3RA2921-2GA00
3RW30/3RW40 soft starters	S2	S2	3RA2931-1AA00	—
3RW30/3RW40 soft starters	S3	S3	3RA1941-1AA00	—
3RF34 solid-state switching devices	S00	S00	3RA2921-1BA00	—
Hybrid link modules for connection of contactors with a spring-loaded connection system to 3RV2 motor starter protectors with a screw-type connection system ¹⁾				
3RT2 contactors with AC or DC coil	S00	S00	3RA2911-2FA00	—
3RT2 contactors with AC or DC coil	S0	S0	3RA2921-2FA00	—

¹⁾ The link modules and hybrid link modules cannot be used for 3RV2.21-4PA1. and 3RV2.21-4FA1. motor starter protectors or 3RV27 and 3RV28 circuit breakers.

7.4.3 SIRIUS 3RA6 compact starters

3RA6 compact starters



Figure 7-24 Compact starter

The SIRIUS 3RA6 compact starter is a compact, highly integrated device which features state-of-the-art controls, including practical diagnostics functions. The compact starter ensures improved efficiency and reliability in the control cabinet.

Table 7- 28 3RA6 compact starters

Area	Customer benefits
Functions	<ul style="list-style-type: none"> • Direct-on-line starter and reversing starter • Short-circuit protection, electronic overload protection, functional switching, and line protection • Mechanical and electrical interlock with reversing starter • IO-Link and AS-i connection • Manual and automatic reset (remote reset via control)
Dimensioning and design	<ul style="list-style-type: none"> • S0 (0.1 up to 32 A/15 kW) • Width of 45 mm (direct-on-line starter) or 90 mm (reversing starter) • 5 setting ranges from 0.1 A to 32 A • Weld-free contacts (remaining lifetime indication) • Screw-type and spring-loaded connection systems with removable terminals in the main and auxiliary circuits

Area	Customer benefits
Mounting advantages	<ul style="list-style-type: none"> • SIRIUS 3RA68 infeed system for simpler, space-saving installation • Connection of cables up to 70 mm² • Coding and locking options in the 3RA6 compact starter • Screw-type and spring-loaded terminals • Removable terminals for easy and quick replacement if service is required (permanent wiring) • Optional control kit for testing the main current path
Application areas/customer benefits	<ul style="list-style-type: none"> • Integrated diagnostics functions • Large wide voltage ranges and wide setting ranges • Three different power infeed options • Comprehensive approvals for global applicability • Fast and standardized configuration thanks to full integration in STEP 7

7.4.3.1 System overview

Features

The SIRIUS compact starter is a universal, weld-free motor feeder in accordance with IEC/EN 60947-6-2. It combines the functions of a circuit breaker, a solid-state overload relay and a contactor within a single enclosure and can be used in any application involving the direct starting of standard three-phase motors with a rating of up to 32 A (approx. 15 kW/400 V).

The compact starter is available as either a direct or a reversing starter.

As an option, an AS-i mounting module can be mounted on the 3RA61/3RA62 compact starter with a 24 V control supply voltage. The AS-i mounting module enables the compact starter to communicate via an AS-Interface.

The 3RA64/3RA65 compact starter with IO-Link can communicate via IO-Link.

Table 7- 29 Compact starter communication options

Compact starter	Communication
3RA61/3RA62 compact starter without optional AS-i mounting module	Communication via auxiliary contacts and signaling contacts
3RA61/3RA62 compact starter (24 V) with optional AS-i mounting module	Communication via AS-Interface
3RA64/3RA65 compact starter with IO-Link	Communication via IO-Link

Accessories

You can find more information in the chapter Manuals - SIRIUS Modular System (Page 26) in the "SIRIUS 3RA6 Compact Starter" manual.

In addition to the 3RA61/3RA62 compact starter and the 3RA64/3RA65 compact starter with IO-Link, this document also describes the following accessories:





Table 7- 30 Accessories for the compact starter

Accessories	Description
Auxiliary switch block for compact starter	Optional auxiliary switch block in the following versions: 2 NO contacts, 2 NC contacts or 1 NO contact + 1 NC contact.
AS-i mounting module	The AS-i mounting module enables the 3RA61/3RA62 compact starter with 24 V control supply voltage to communicate via an AS-Interface.
Control kit	Tool for closing the main contacts manually by means of the handle.
Adapter for screw fastening the compact starter	The adapters for screw fastening enable you to install the compact starter on a level surface (screw fastening).
Terminals for "Combination Controller Type E"	The terminals conform to the clearances and creepage distances stipulated by UL 508 (Type E).
Infeed system for 3RA6	The infeed system for 3RA6 is a modular infeed system with an optional PE system. The permanent wiring means that compact starters can be mounted quickly and easily.
3-phase busbar	The 3-phase busbar enables several compact starters to be fed using a single infeed terminal.
8US busbar adapter	The 8US busbar adapter enables the compact starter to be mechanically fastened and electrically connected to a busbar system.
Door-coupling rotary operating mechanism	Door-coupling rotary operating mechanisms enable compact starters to be operated with the control cabinet doors closed.

Versions

The 3RA6 compact starter is available in the following versions:

Table 7- 31 3RA6 compact starter versions

Version	Image
Compact starter direct-on-line version	
Compact starter reversing version	
Compact starter direct-on-line, IO-Link version	
Compact starter reversing, IO-Link version	

Accessories for 3RA6 compact starters

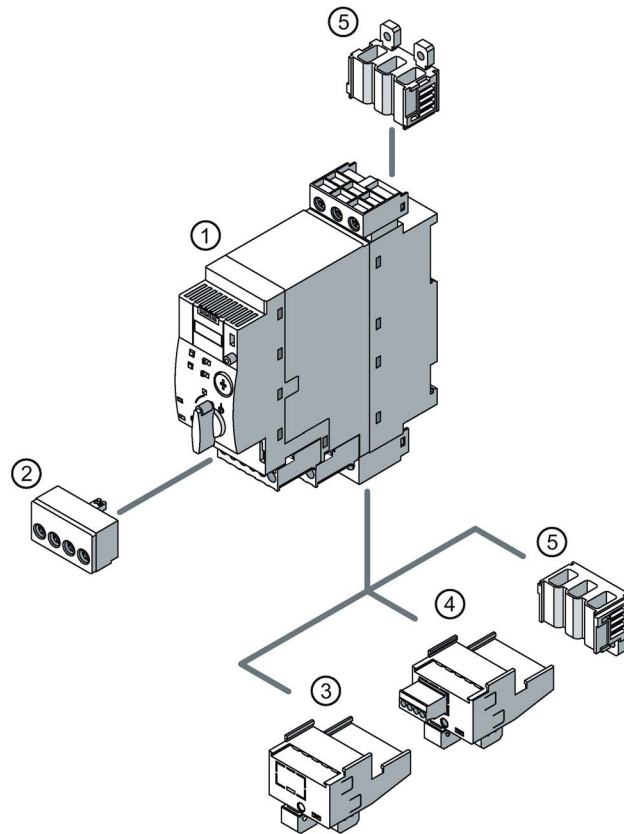

- 1 3RA6 compact starter
- 2 External auxiliary switch block
- 3 AS-i add-on module
- 4 AS-i add-on module with:
 - Two local inputs for safe disconnection
 - Two additional digital inputs
 - One additional digital input and one digital output
 - Two additional digital outputs
 - For on-site control
- 5 Adapter for screw mounting

Figure 7-25 Accessories for 3RA6 compact starters

Infeed system for 3RA6 compact starter

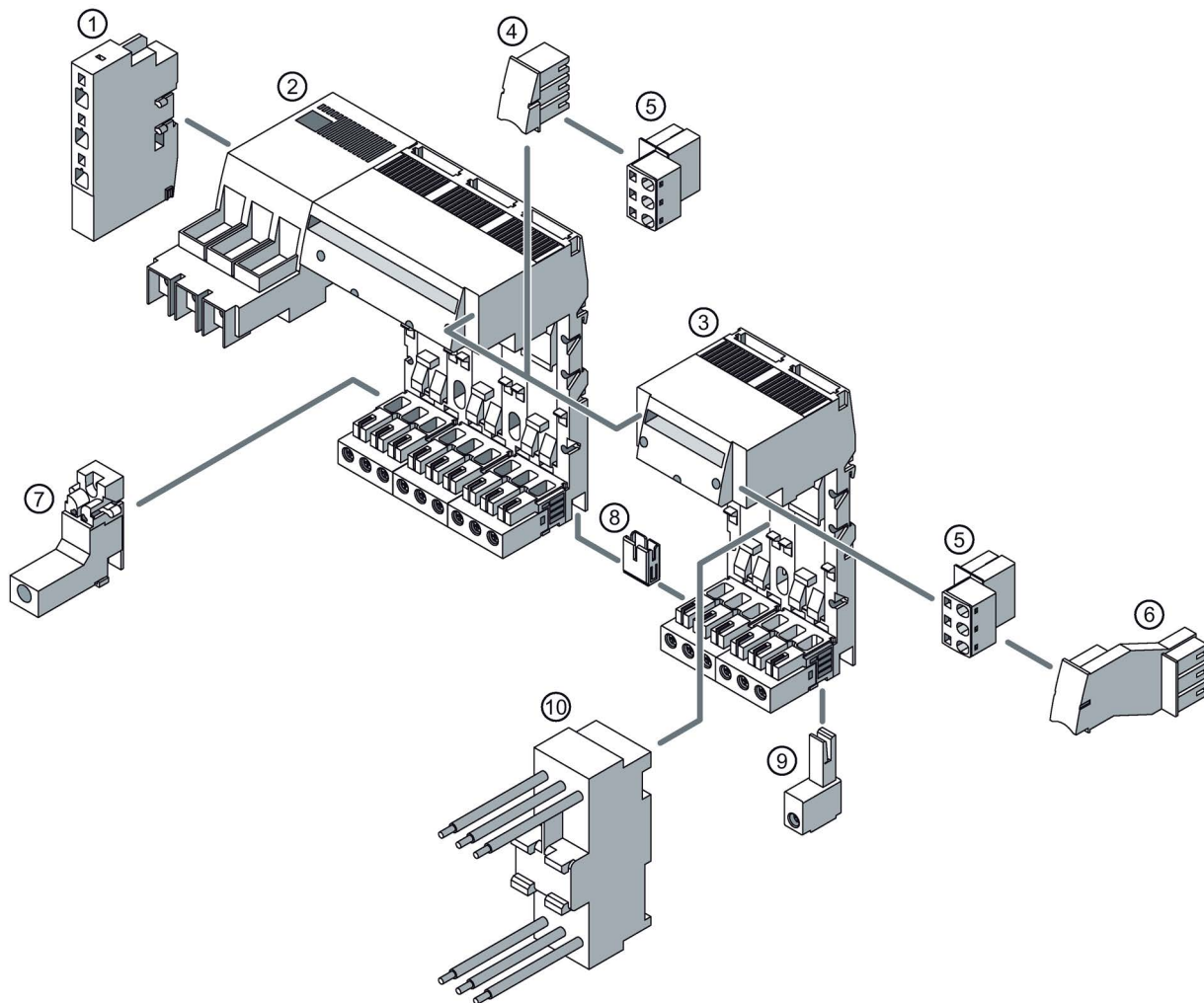

- 1 Infeed on left or right using spring-loaded connection system
- 2 Infeed on left using screw-type connection system
- 3 Expansion module
- 4 Expansion plug
- 5 Terminal block
- 6 Expansion plug for 3RV19
- 7 PE infeed
- 8 PE expansion plug
- 9 PE tap
- 10 45 mm adapter for infeed system for 3RA6

Figure 7-26 Infeed system for 3RA6 compact starter

Reference

More information ...	Is available in ...
about the 3RA6 compact starters	the chapter "Manuals - SIRIUS Modular System (Page 26)" in the "SIRIUS 3RA6 Compact Starter" manual.

Mounting and disassembly

Mounting and disassembly

Within each device size, the mounting options are identical.

Table 8- 1 Mounting options

Size	Mounting	Disassembly
S00, S0, S2, S3	Screw mounting	Disassembly with a screwdriver
	Snap-on mounting on 35 mm DIN rail (according to DIN EN 60715) or 75 mm DIN rail (size S3)	<ul style="list-style-type: none"> Disassembly without tools (size S00 / S0) Disassembly with a screwdriver (size S2 / S3)
S6, S10, S12	Screw mounting (wall mounting or base plate)	Disassembly with a screwdriver

8.1 Screw mounting

Screw mounting

SIRIUS switching devices can be screwed onto a level surface.

Push-in lugs are required in order to fasten the 3RV2 motor starter protectors with screws.

8.2 Snap-on mounting

Snap-on mounting

SIRIUS switching devices in sizes S00 to S3 are snapped onto 35 mm DIN rails according to DIN EN 60 715, without tools.

The tables below describe how to snap a component onto a DIN rail, using a contactor (size S00) as an example. The procedure is the same for all SIRIUS switching devices.

Mounting on a DIN rail

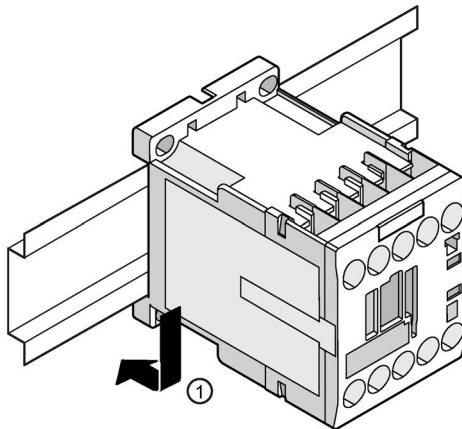

- ① Position the device on the top edge of the DIN rail. Press down until it snaps onto the bottom edge of the DIN rail.

Disassembling from a DIN rail

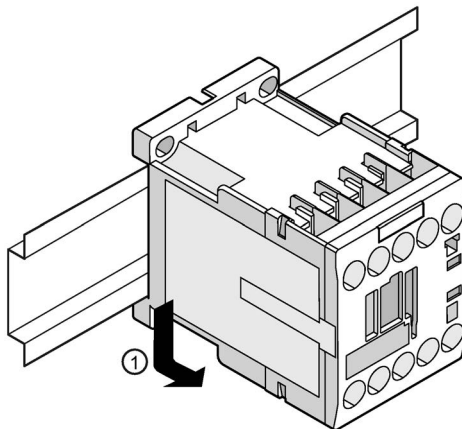

- ① To disassemble the device, press it down, pushing against the mounting springs. Swivel the device to remove it.

Snapping onto / off DIN rail (size S2)

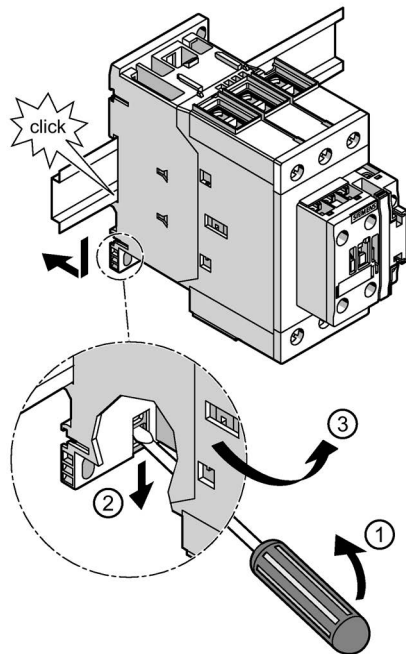

- ① / ② / ③ Position the device on the top edge of the DIN rail and press down until it snaps onto the bottom edge of the DIN rail.
- To disassemble the device, push down the lock with a screwdriver. (①/②) Then push the device down against the pull of the mounting springs, and swivel the device to remove it. ③

Snapping onto DIN rail (size S3)

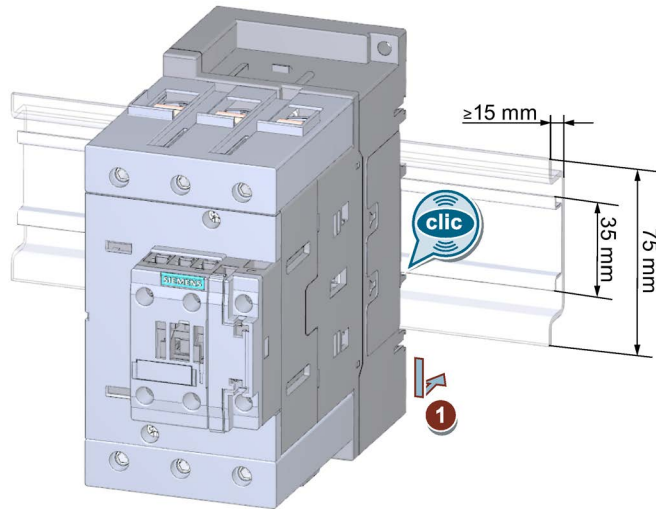

- ① Position the device on the top edge of the DIN rail and press down until it snaps onto the bottom edge of the DIN rail.

Snapping off DIN rail (size S3)

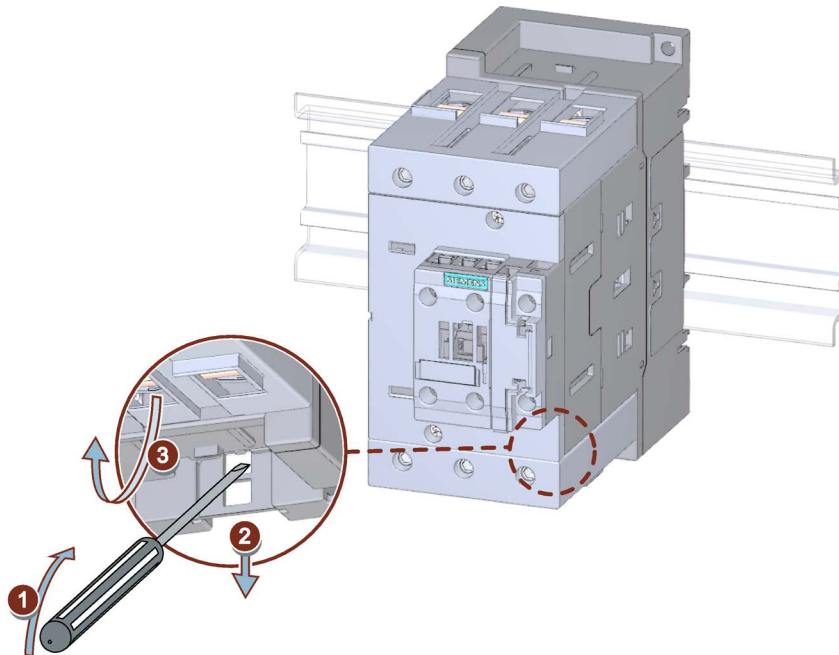

- ① / ② / ③ To disassemble the device, push down the lock with a screwdriver. (①/②) Then push the device down against the pull of the mounting springs, and swivel the device to remove it. ③

Refer to the product manuals or operating instructions for specific details of how to snap the different devices onto DIN rails.

Connection

9.1 Connection systems

9.1.1 Screw connection

Screw connection

Within each device size, the terminals are identical. Therefore, the same tool can be used thanks to the same conductor cross-sections and tightening torques within one size. The stripped lengths are identical too; this is important for pre-assembled cables.

Size S00, S0 and S2 devices feature screw-type terminals with captive screws and terminal washers. The screw-type terminals also allow for the connection of 2 conductors with different cross-sections.



! DANGER

Hazardous voltage.

Will cause death or serious injury.

Turn off and lock out all power supplying this device before working on this device.

Use the following tool to establish the connection: The screws are designed for a size PZ 2 Pozidriv screwdriver at rated currents of up to 80 A.

9.1.2 Spring-loaded connection

Spring-loaded connection

The devices in the SIRIUS modular system are available with spring-loaded connection system. Spring-loaded connection makes wiring quick and maintenance-free, while also meeting high demands in terms of vibration and shock resistance. In sizes S00 and S0, spring-loaded connection is possible in both the main circuit and the auxiliary circuit. As from size S2, spring-loaded connection is possible in the auxiliary circuit.

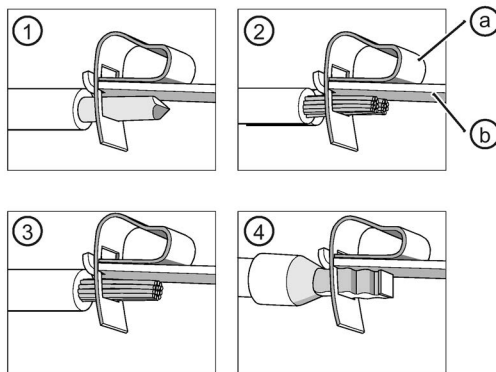

- ① Solid
- ② Finely stranded
- ③ Stranded
- ④ Finely stranded with end sleeve
- a Spring-loaded terminal
- b Busbar

Figure 9-1 Spring-loaded terminal

The spring-loaded terminal on the switching devices clamps copper conductors from 0.25 mm² (removable terminal) to 10 mm² (main circuit terminal, size S0). You can find more detailed information in the SIRIUS modular system manuals (Page 26). The conductors can be clamped directly or you can pre-treat them to add a form of splice protection. This could involve attaching end sleeves or pin cable lugs to the ends of the conductors; the tidiest solution is to use conductors whose ends have been sealed by means of ultrasound.

The devices are equipped with a two-wire connection, i.e. two independent connections per current path. Just one conductor is connected to each clamping point. The spring-loaded terminal presses the conductor against the busbar, which curves around inside the terminal. The high contact pressure per unit area achieved in this way is gas-tight. The spring-loaded terminal presses flat against the conductor, but does not damage it. The spring force of the spring-loaded terminal has been dimensioned such that the clamping force adjusts to the conductor diameter automatically. This ensures that any conductor deformation caused by settling, creepage, or yielding is compensated for. The clamping point cannot become loose of its own accord. This connection is vibration- and shock-proof. Vibrations or shocks will not damage the conductor, nor will they cause contact separation. These terminals are particularly well suited for use with machines and systems which are subject to stresses such as these, e.g. vibrators, rail vehicles, and elevators.

Catalog IC 10 "SIRIUS Industrial Controls" offers a standard screwdriver, which can be used as the operating tool for opening the spring-loaded connections.

The table below describes the procedure for creating a spring-loaded connection:



! DANGER

Hazardous voltage.
 Will cause death or serious injury.
 Turn off and lock out all power supplying this device before working on this device.

NOTICE

Damage to the spring-loaded terminal!
 If you insert the screwdriver into the central opening on the spring-loaded terminal, this could damage the terminal.
 Do not insert the screwdriver into the central opening on the spring-loaded terminal.

Table 9- 1 Connecting the spring-loaded terminal

Step	Operating instruction	Image
1	Insert the screwdriver into the bottommost (A) or topmost (B) operating slot on the right-hand side.	
2	Press the screwdriver down (A) or up (B), then push it into the operating slot as far as it will go. The screwdriver blade keeps the spring-loaded terminal open automatically.	
3	Insert the conductor into the oval connection slot.	
4	Remove the screwdriver. The terminal closes and the conductor is now securely clamped.	

Link modules

Link modules enable load feeders to be assembled without tools, simply by plugging the relevant devices in.

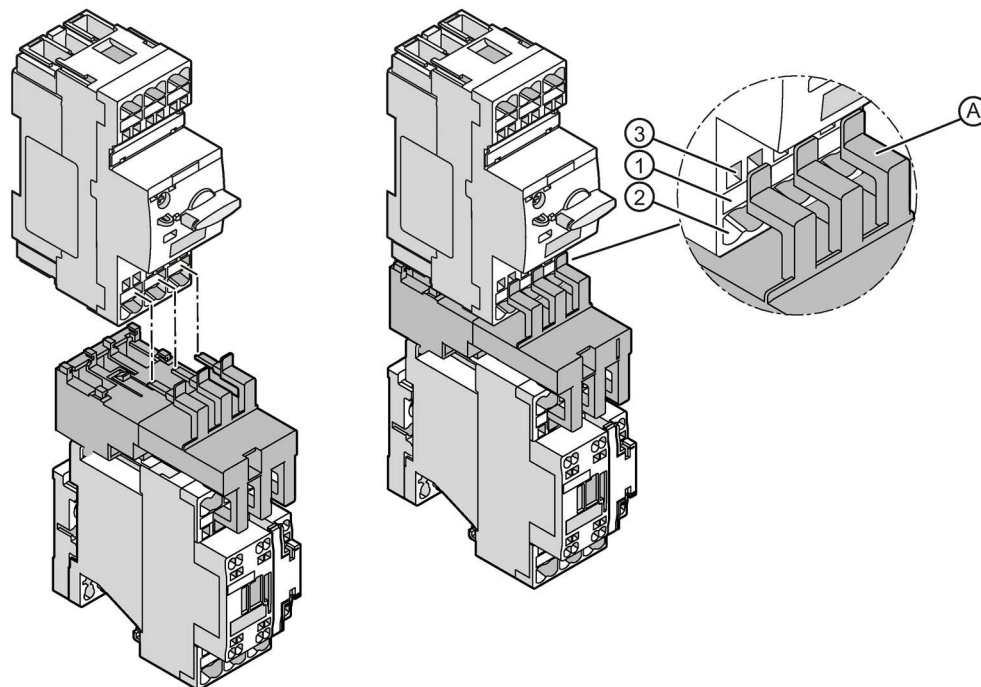

- A Link module
- ① Slot for link modules
- ② Slot for conductor connection
- ③ Screwdriver opening for mounting/disassembly without a link module

Figure 9-2 Link module

NOTICE

Damage to the spring-loaded terminal of the link module

If a conductor is plugged into the socket for conductor connection when a link module is used, it can be damaged.

If a link module is used, do not plug a conductor into the slot for conductor connection.

Insulating stop

With conductor cross-sections which are $\leq 1 \text{ mm}^2$, you should use an insulating stop to prevent the conductor insulation from being clamped. The insulating stop can be used with the following devices:

Table 9- 2 Overview table - Use of insulating stop for conductor cross-sections $\leq 1 \text{ mm}^2$ (size S00 / S0)

	Size S00		Size S0	
	Main circuit	Control circuit	Main circuit	Control circuit
3RT2/3RH2 contactors (basic devices)	2	2	—	1
Accessories for 3RT2 contactors (e.g. auxiliary switches)	—	1	—	1
3RF34 solid-state switching devices	—	—	2	—
3RW30 / 40 soft starters	2	0	—	0
3RV2 motor starter protectors (basic devices)	2	1	—	1
Accessories for 3RV2 motor starter protectors (e.g. auxiliary switches)	—	1	—	1
3RU2 thermal overload relays	—	1	—	1
3RB3 electronic overload relays	—	0	—	0
3RA6 compact starters	—	—	—	0
3RA27/3RA28 function modules	—	0	—	0
3RR2 current monitoring relays	—	0	—	0

0: No insulating stop required

1: 3RT1916-4JA02 insulating stop

2: 3RT2916-4JA02 insulating stop

—: Not relevant (e.g. conductor cross-section $\leq 1 \text{ mm}^2$) or not available

Table 9- 3 Overview table - Use of insulating stop for conductor cross-sections $\leq 1 \text{ mm}^2$ (size 2)

	Sizes S2 and S3	
	Main circuit	Control circuit
3RT2/3RH2 contactors (basic devices)	—	1
Accessories for 3RT2 contactors (e.g. auxiliary switches)	—	1
3RW30 / 40 soft starters	—	0
3RV2 motor starter protectors (basic devices)	—	1
Accessories for 3RV2 motor starter protectors (e.g. auxiliary switches)	—	1
3RU2 thermal overload relays	—	1
3RB3 electronic overload relays	—	0
3RA27/3RA28 function modules	—	0
3RR2 current monitoring relays	—	0

0: No insulating stop required

1: 3RT1916-4JA02 insulating stop

—: Not relevant (e.g. conductor cross-section $\leq 1 \text{ mm}^2$) or not available

The graphic below shows how the insulating stop is used:

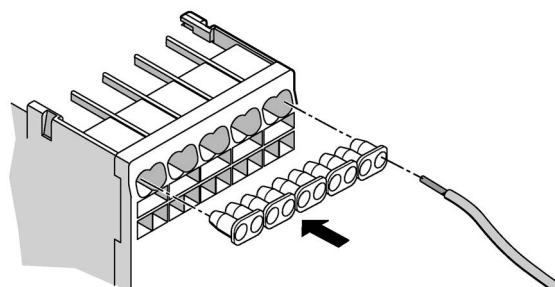

Figure 9-3 Insulating stop on spring-loaded connection system

9.1.3 Ring cable lug connection

Ring cable lug connection (sizes S00 and S0)

The ring cable lug connection is equipped with an M3 or M4 combination screw. A special cover ensures finger-safety.



! DANGER
Hazardous voltage.
Will cause death or serious injury.
Turn off and lock out all power supplying this device before working on this device.

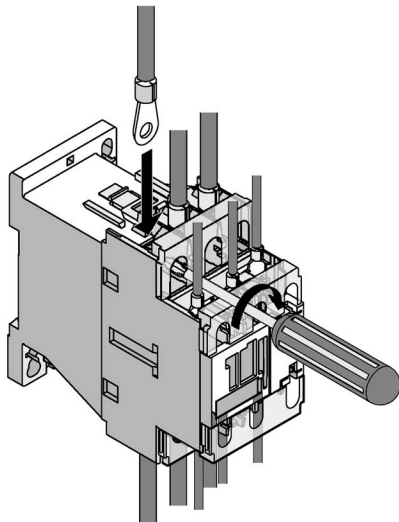

Figure 9-4 Ring cable lug connection system

9.2 Conductor cross-sections

Conductor cross-sections

Due to SIRIUS being a modular system, the conductor cross-sections of all the devices of one size are identical.

9.2.1 Conductor cross-sections for screw-type connection systems

Conductor cross-sections for screw-type connection systems

The tables below define the permissible conductor cross-sections for main terminals and auxiliary conductor connections in sizes S00, S0 and S2 for screw-type connection systems.

Table 9- 4 Main conductors of size S00 with M3 combination screws

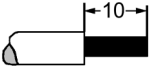
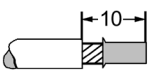
		Motor starter protectors	Contactors	Overload relays ¹⁾ , current monitoring relays ¹⁾
Tool		Pozidriv size PZ 2, Ø 5 ... 6 mm		
Tightening torque		0.8 to 1.2 Nm		
Solid and stranded			2 x (0.5 ... 1.5) mm ²	2 x (0.5 ... 1.5) mm ²
		2 x (0.75 ... 2.5) mm ²	2 x (0.75 ... 2.5) mm ²	2 x (0.75 ... 2.5) mm ²
		Max. 2 x 4 mm ²	Max. 2 x 4 mm ²	Max. 2 x 4 mm ²
Finely stranded with end sleeve		2 x (0.5 ... 1.5) mm ²	2 x (0.5 ... 1.5) mm ²	2 x (0.5 ... 1.5) mm ²
		2 x (0.75 ... 2.5) mm ²	2 x (0.75 ... 2.5) mm ²	2 x (0.75 ... 2.5) mm ²
AWG			2 x (20 to 16)	2 x (20 to 16)
		2 x (18 to 14)	2 x (18 to 14)	2 x (18 to 14)
		2 x 12	2 x 12	2 x 12

¹⁾ Only 1 conductor can be clamped on the stand-alone assembly support.

9.2 Conductor cross-sections

Table 9- 5 Main conductors of size S0 with M4 combination screws

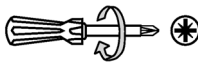
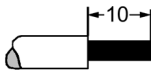
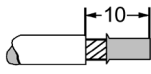
		Motor starter protector	Contactors	Overload relay ¹⁾ , current monitoring relay ¹⁾
Tool		Pozidriv size PZ 2, Ø 5 ... 6 mm		
Tightening torque		2.0 to 2.5 Nm		
Solid and stranded		2 x (1.0 to 2.5) mm ²	2 x (1.0 to 2.5) mm ²	2 x (1.0 to 2.5) mm ²
		2 x (2.5 to 10) mm ²	2 x (2.5 to 10) mm ²	2 x (2.5 to 10) mm ²
Finely stranded with end sleeve		2 x (1 to 2.5) mm ²	2 x (1 to 2.5) mm ²	2 x (1 to 2.5) mm ²
		2 x (2.5 to 6) mm ²	2 x (2.5 to 6) mm ²	2 x (2.5 to 6) mm ²
		Max. 1 x 10 mm ²	Max. 1 x 10 mm ²	Max. 1 x 10 mm ²
AWG		2 x (16 to 12)	2 x (16 to 12)	2 x (16 to 12)
		2 x (14 to 8)	2 x (14 to 8)	2 x (14 to 8)

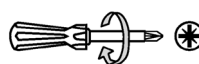
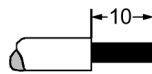
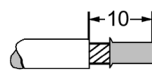

1) Only 1 conductor can be clamped on the stand-alone assembly support.

Table 9- 6 Main conductors of size S2 with box terminal

		Motor starter protectors		Contactors	Overload relays ¹⁾ , current monitoring relays ¹⁾
		3RV2.31- 4S/T/B/D/E/P/U/V.1	3RV2.31- 4W/X/J/K/R.1. 3RV2431-4VA1. 3RV2.32-...		
Tool		Pozidriv size PZ 2, Ø 5 ... 6 mm			
Tightening torque		3.0 ... 4.5 Nm			
Solid and stranded		2 x (1.0 ... 25) mm ²	2 x (1.0 ... 35) mm ²	2 x (1.0 ... 35) mm ²	2 x (1.0 ... 35) mm ²
		1 x (1.0 ... 35) mm ²	1 x (1.0 ... 50) mm ²	2 x (1.0 ... 50) mm ²	1 x (1.0 ... 50) mm ²
Finely stranded with end sleeve		2 x (1.0 ... 16) mm ²	2 x (1.0 ... 25) mm ²	2 x (1.0 ... 25) mm ²	2 x (1.0 ... 25) mm ²
		1 x (1.0 ... 25) mm ²	1 x (1.0 ... 35) mm ²	1 x (1.0 ... 35) mm ²	1 x (1.0 ... 35) mm ²
AWG		2 x (18 to 3)	2 x (18 to 2)	2 x (18 to 2)	2 x (18 to 2)
		1 x (18 to 2)	1 x (18 to 1)	1 x (18 to 1)	1 x (18 to 1)

1) Only 1 conductor can be clamped on the stand-alone assembly support.

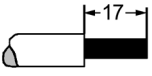
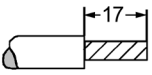
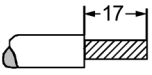
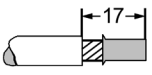
Table 9- 7 Main conductors of size S3 with box terminal block

		Contactors, overload relays, motor starter protectors
Tool		4 mm Allen key
Tightening torque		4.5 ... 6.0 Nm
Solid		2 x (2.5 ... 16) mm ²
Stranded		2 x (6 ... 16) mm ²
		2 x (10 ... 50) mm ²⁽¹⁾
		1 x (10 ... 70) mm ²
Finely stranded without end sleeve		-
Finely stranded with end sleeve		2 x (2.5 ... 35) mm ²
		1 x (2.5 ... 50) mm ²
Ribbon cables		2 x (6 x 9 x 0.8)
AWG		2 x (10 to 1/0)
		1 x (10 to 2/0)

9.2 Conductor cross-sections

Table 9- 8 Main conductors of size S6 with box terminal block







		Contactor with 3RT1955-4G box terminal block		
Tool		 4 mm Allen key		
Tightening torque		10.0 ... 12.0 Nm		
				
Solid		1 x (16 ... 70) mm ²	1 x (16 ... 70) mm ²	max. 50 + 70 mm ²
Finely stranded with end sleeve		1 x (16 ... 70) mm ²	1 x (16 ... 70) mm ²	max. 50 + 70 mm ²
Ribbon cables		min. 3 x 9 x 0.8 max. 6 x 15.5 x 0.8		
AWG		1 x (AWG 6 to 2/0)	1 x (AWG 6 to 2/0)	max. AWG 1/0 + 1/0

Table 9- 9 Main conductors of size S6 with box terminal block

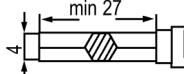



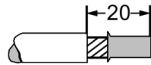

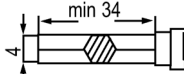

		Contactor with 3RT1956-4G box terminal block		
Tool		 4 mm Allen key		
Tightening torque		10.0 ... 12.0 Nm		
				
Solid		1 x (16 ... 120) mm ²	1 x (16 ... 120) mm ²	max. 95 + 120 mm ²
Finely stranded with end sleeve		1 x (16 ... 120) mm ²	1 x (16 ... 120) mm ²	max. 95 + 120 mm ²
Ribbon cables		min. 3 x 9 x 0.8 max. 10 x 15.5 x 0.8		
AWG		1 x (AWG 6 to 250 kcmil)	1 x (AWG 6 to 250 kcmil)	max. AWG 3/0 + 3/0

Table 9- 10 Main conductors of size S6 with box terminal block

		Electronic overload relay with box terminal block 3RT1955-4G	Electronic overload relay with box terminal block 3RT1956-4G
Tool		 4 mm Allen key	 4 mm Allen key
Tightening torque		10.0 ... 12.0 Nm	
Solid		–	
Stranded		2 x (max. 70) mm ²	2 x (max. 120) mm ²
		1 x (16 ... 70) mm ²	1 x (16 ... 120) mm ²
Finely stranded without end sleeve		2 x (1 x max. 50, 1 x max. 70) mm ²	2 x (1 x max. 95, 1 x max. 120) mm ²
		1 x (1 ... 70) mm ²	1 x (10 ... 120) mm ²
Finely stranded with end sleeve		2 x (1 x max. 50, 1 x max. 70) mm ²	2 x (1 x max. 95, 1 x max. 120) mm ²
		1 x (1 ... 70) mm ²	1 x (10 ... 120) mm ²
Ribbon cables		2 x (6 x 15.5 x 0.8)	2 x (10 x 15.5 x 0.8)
		1 x (3 x 9 x 0.8 ... 6 x 15.5 x 0.8)	1 x (3 x 9 x 0.8 ... 10 x 15.5 x 0.8)
AWG		2 x (max. 1/0)	2 x (max. 3/0)
		1 x (6 ... 2/0)	1 x (6 ... 250 kcmil)

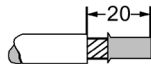
9.2 Conductor cross-sections

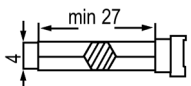
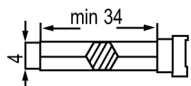
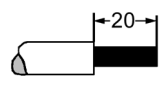
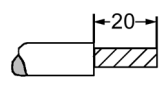
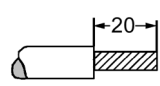
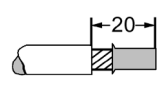
Table 9- 11 Main conductors of size S10 / S12 with box terminal block







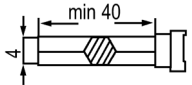

		Contactor with 3RT1966-4G box terminal block		
Tool		 5 mm Allen key		
Tightening torque		20.0 ... 22.0 Nm		
				
Solid		1 x (95 ... 300) mm ²	1 x (120 ... 240) mm ²	min. 70 + 70 mm ² max. 240 + 240 mm ²
Finely stranded with end sleeve		1 x (70 ... 240) mm ²	1 x (120 ... 185) mm ²	min. 50 + 50 mm ² max. 185 + 185 mm ²
Ribbon cables		min. 6 x 9 x 0.8 max. 20 x 24 x 0.5 11 x 21 x 1		
AWG		1 x (AWG 3/0 to 600 kcmil)	1 x (AWG 250 to 500 kcmil)	max. AWG 2/0 + 2/0 max AWG 500 + 500

Table 9- 12 Main conductors of size S10 / S12 with box terminal block

		Electronic overload relay with 3RT1966-4G box terminal block
Tool		5 mm Allen key
Tightening torque		20.0 ... 22.0 Nm
Solid		–
Stranded		2 x (70 ... 240) mm ² Front clamping point only: 1 x (95 ... 300) mm ² Rear clamping point only: 1 x (120 ... 240) mm ²
Finely stranded without end sleeve		2 x (50 ... 185) mm ² Front clamping point only: 1 x (70 ... 240) mm ² Rear clamping point only: 1 x (120 ... 185) mm ²
Finely stranded with end sleeve		2 x (50 ... 185) mm ² Front clamping point only: 1 x (70 ... 240) mm ² Rear clamping point only: 1 x (120 ... 185) mm ²
Ribbon cables		2 x (20 x 24 x 0.5) 1 x (6 x 9 x 0.8 ... 20 x 24 x 0.5)
AWG		2 x (2/0 ... 500 kcmil) Front clamping point only: 1 x (3/0 ... 600 kcmil) Rear clamping point only: 1 x (250 ... 500 kcmil)

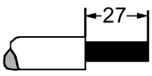
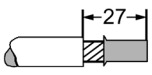
9.2 Conductor cross-sections

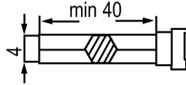
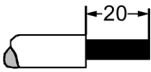
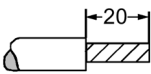
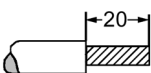
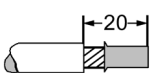
Table 9- 13 Auxiliary conductors of sizes S00 / S0 / S2 / S3 with M3 combination screws

		Accessories for motor starter protectors, accessories for contactors, overload relays	Contactors, size S00	Contactors, thermal overload relay, sizes S0, S2 and S3
Tool		Pozidriv size PZ 2, Ø 5 ... 6 mm		
Tightening torque		0.8 ... 1.2 Nm		0.8 ... 1.2 Nm
Solid and stranded		2 x (0.5 ... 1.5) mm ²	2 x (0.5 ... 1.5) mm ²	2 x (0.5 ... 1.5) mm ²
		2 x (0.75 ... 2.5) mm ²	2 x (0.75 ... 2.5) mm ²	2 x (0.75 ... 2.5) mm ²
			Max. 2 x 4 mm ²	
Finely stranded with end sleeve		2 x (0.5 ... 1.5) mm ²	2 x (0.5 ... 1.5) mm ²	2 x (0.5 ... 1.5) mm ²
		2 x (0.75 ... 2.5) mm ²	2 x (0.75 ... 2.5) mm ²	2 x (0.75 ... 2.5) mm ²
AWG		2 x (20 to 16)	2 x (20 to 16)	2 x (20 to 16)
		2 x (18 to 14)	2 x (18 to 14)	2 x (18 to 14)
			2 x 12	

Table 9- 14 Removable terminal for auxiliary conductor on the electronic overload relay

		Removable terminal for auxiliary conductor on the electronic overload relay
Tool		Pozidriv size PZ 2, Ø 6 mm
Tightening torque		0.8 ... 1.2 Nm
Solid and stranded		1 x (0.5 to 4) mm ²
		2 x (0.5 to 2.5) mm ²
Finely stranded with end sleeve		1 x (0.5 to 2.5) mm ²
		2 x (0.5 ... 1.5) mm ²
AWG		2 x (20 to 14)

Table 9- 15 S00 and S0 capacitor contactors

		A1/A2, NO/NC	Contactors, size S00	Contactors, size S0	
			L1, L2, L3 3RT261.-1	L1, L2, L3 3RT262.-1	3RT262.-1 + 3RV2925-5AB
Tool		Pozidriv size PZ 2, Ø 5 ... 6 mm	Pozidriv size PZ 2, Ø 5 ... 6 mm	Pozidriv size PZ 2, Ø 5 ... 6 mm	Pozidriv size PZ 2, Ø 5 ... 6 mm
Tightening torque		0.8 ... 1.2 Nm (7 to 10.3 lb·in)	0.8 ... 1.2 Nm (7 to 10.3 lb·in)	2 ... 2.5 Nm (18 to 22 lb·in)	3 ... 4 Nm (27 to 35.2 lb in)
Solid and stranded		2 x (0.5 ... 1.5) mm ²	2 x (0.5 ... 1.5) mm ²	2 x (1 ... 2.5) mm ²	1 x (2.5 ... 25) mm ²
		2 x (0.75 ... 2.5) mm ²	2 x (0.75 ... 2.5) mm ²	2 x (2.5 ... 10) mm ²	
		2 x 4 mm ²	2 x 4 mm ²		
Finely stranded with end sleeve		2 x (0.5 ... 1.5) mm ²	2 x (0.5 ... 1.5) mm ²	2 x (1 ... 2.5) mm ²	1 x (2.5 ... 16) mm ²
		2 x (0.75 ... 2.5) mm ²	2 x (0.75 ... 2.5) mm ²	2 x (2.5 ... 6) mm ²	
				1 x 10 mm ²	
AWG		2 x (20 ... 16)	2 x (20 ... 16)	2 x (14 to 8)	1 x (10 to 4)
		2 x (18 ... 14)	2 x (18 ... 14)		
		2 x 12	2 x 12		

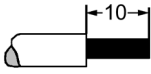
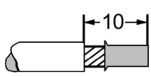
Table 9- 16 Capacitor contactors main conductors of size S2 (3RT263.-1)

		L1, L2, L3 3RT263.-1
Tool		Pozidriv size PZ 2, Ø 5 ... 6 mm
Tightening torque		3.0 ... 4.5 Nm (27 to 40 lb in)
Solid and stranded		2 x (1 to 35) mm ²
		1 x (1 to 50) mm ²
Finely stranded with end sleeve		2 x (1 to 25) mm ²
		1 x (1 to 35) mm ²
AWG		2 x (18 to 2)
		1 x (18 to 0)

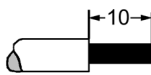
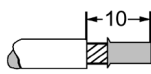
9.2 Conductor cross-sections

Table 9- 17 Capacitor contactors auxiliary conductors of size S2 (3RT263.-1)

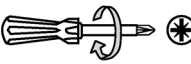
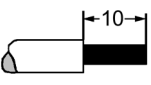
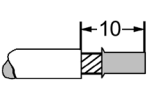
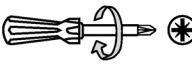
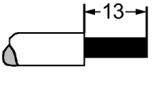
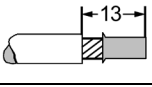
		A1/A2, NO/NC 3RT263.-1 3RH29.1-1
Tool		Pozidriv size PZ 2, Ø 5 ... 6 mm
Tightening torque		M3: 0.8 ... 1.2 Nm (7 to 10.3 lb in)
Solid and stranded		2 x (0.5 ... 1.5)
		2 x (0.75 ... 2.5)
		2 x 4
Finely stranded with end sleeve		2 x (0.5 ... 1.5)
		2 x (0.75 ... 2.5)
AWG		2 x (20 to 16)
		2 x (18 to 14)
		2 x 12

Table 9- 18 Capacitor contactors S2 (3RT263.-1 + 3RV2935-5A)

		3RT263.-1 + 3RV2935-5A
Tightening torque		4 ... 6 Nm (35 to 53 lb in)
Solid and stranded		2 x (2.5 to 50) mm ²
		1 x (2.5 to 70) mm ²
Finely stranded with end sleeve		2 x (2.5 to 35) mm ²
		1 x (2.5 to 50) mm ²
AWG		2 x (10 to 1 / 0)
		1 x (10 to 2 / 0)

Table 9- 19 Capacitor contactors S2 (3RT2637)

		L1, L2, L3 3RT2637	
I_{rms}		≤ 133 A	> 133 A
Finely stranded		1 x 50 mm ²	2 x 35 mm ²
AWG		1 x 0	2 x 2
Rated fuse current		Max. 200 A	Max. 160 A

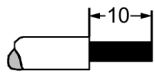
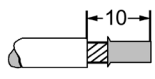
Table 9- 20 Main conductor connection of size S2 with through-hole technology

		<p>Electronic overload relay</p> <p>The maximum diameter of the opening is 12.8 mm.</p>
---	---	--

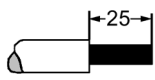
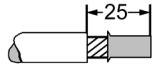
Table 9- 21 Main conductor connection of size S3 with through-hole technology

		<p>Electronic overload relay</p> <p>The maximum diameter of the opening is 18 mm.</p>
--	--	--

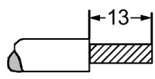
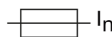
Table 9- 22 Main conductor connection of size S6 with through-hole technology

		<p>Electronic overload relay</p> <p>The maximum diameter of the opening is 24.5 mm.</p>
---	---	--

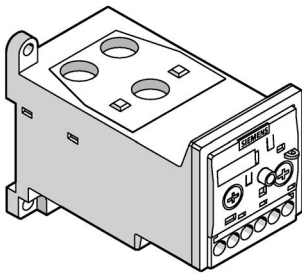
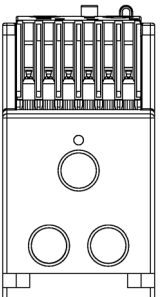
9.2.2 Conductor cross-sections for spring-loaded connection systems

Conductor cross-sections for spring-loaded connection systems

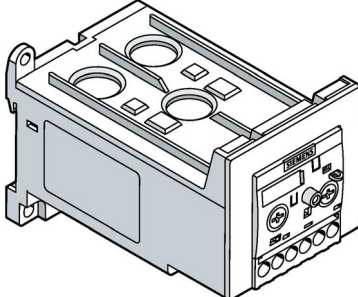
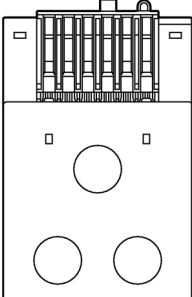
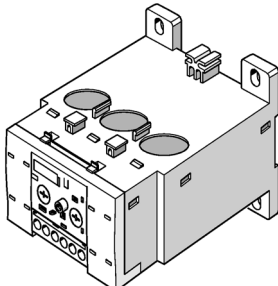
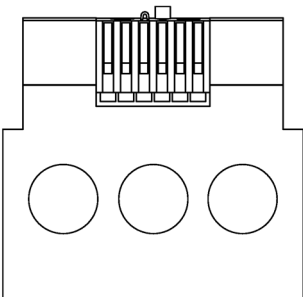
The tables below define the permissible conductor cross-sections for main terminals (sizes S00 and S0) and auxiliary conductor connections (sizes S00, S0, S2 and S3) for spring-loaded connection systems.

Table 9- 23 Main conductors of size S00

		Motor starter protectors, contactors	Overload relays, current monitoring relays
Tool		Ø 3.0 x 0.5 (3RA2808-1A)	
Solid and stranded		2 x (0.5 to 4.0) mm ²	0.5 to 4.0 mm ²
Finely stranded without end sleeve		2 x (0.5 to 2.5) mm ²	0.5 to 2.5 mm ²
Finely stranded with end sleeve (DIN 46 228 Part 1)		2 x (0.5 to 2.5) mm ²	0.5 to 2.5 mm ²
AWG		2 x (20 to 12)	2 x (20 to 12)

Table 9- 24 Main conductors of size S0

		Motor starter protectors, contactors	Overload relays, current monitoring relays
Tool		Ø 3.0 x 0.5 (3RA2808-1A)	
Solid and stranded		2 x (1.0 to 10) mm ²	1.0 to 10 mm ²
Finely stranded without end sleeve		2 x (1.0 to 6.0) mm ²	1.0 to 6.0 mm ²
Finely stranded with end sleeve (DIN 46 228 Part 1)		2 x (1.0 to 6.0) mm ²	1.0 to 6.0 mm ²
AWG		2 x (18 to 8)	2 x (18 to 8)

Table 9- 25 Auxiliary conductors of sizes S00 / S0 / S2 / S3

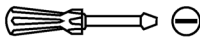
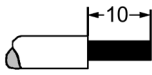
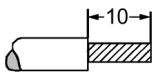
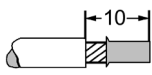

		Contactors, size S00, basic devices	Contactors, sizes S0, S2 and S3, integrated auxiliary switches, overload relays, accessories for contactors, accessories for motor starter protectors
Tool		Ø 3.0 x 0.5 (3RA2808-1A)	
Solid and stranded		2 x (0.5 to 4) mm ²	2 x (0.5 to 2.5) mm ²
Finely stranded without end sleeve		2 x (0.5 to 2.5) mm ²	2 x (0.5 to 2.5) mm ²
Finely stranded with end sleeve (DIN 46 228 Part 1)		2 x (0.5 to 2.5) mm ²	2 x (0.5 ... 1.5) mm ²
AWG		2 x (20 to 12)	2 x (20 to 14)

Table 9- 26 Removable terminal for auxiliary conductor on the 3RB3 electronic overload relay

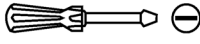
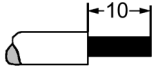
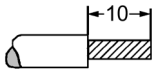
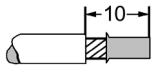
		Removable terminal
Tool		Ø 3.0 x 0.5 (3RA2808-1A)
Solid and stranded		2 x (0.25 to 1.5) mm ²
Finely stranded without end sleeve		2 x (0.25 to 1.5) mm ²
Finely stranded with end sleeve		2 x (0.25 to 1.5) mm ²
AWG		2 x (24 to 16)

9.2.3 Conductor cross-sections for ring cable lug connection system

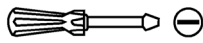
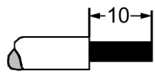
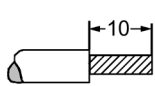
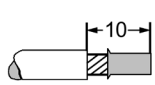
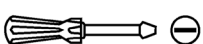
Conductor cross-sections for ring cable lug connection system

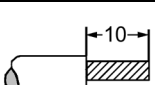
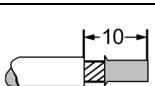
The tables below define the permissible conductor cross-sections for main terminals and auxiliary conductor connections for ring cable lug connection systems.

Table 9- 27 Main conductors and auxiliary conductors of size S00 with M3 combination screws

		SIRIUS devices
Tool		Pozidriv size 2, Ø 5 to 6 mm
Tightening torque		0.8 to 1.2 Nm
Ring cable lug ¹⁾		d ₂ = min. 3.2 mm
		d ₃ = max. 7.5 mm

Table 9- 28 Main conductors and auxiliary conductors of size S0 with M4 combination screws



		SIRIUS devices
Tool		Pozidriv size 2, Ø 5 to 6 mm
Tightening torque		2.0 to 2.5 Nm
Ring cable lug ¹⁾		d ₂ = min. 4.3 mm
		d ₃ = max. 12.2 mm

Table 9- 29 Main conductors of size S3 with M6 screws

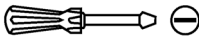
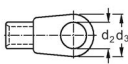
		SIRIUS devices
Tool		4 mm Allen key
Tightening torque		4.5 ... 6.0 Nm
Busbars (M6 x 25)		2 x 12 x 4
Ring cable lug ¹⁾		d ₂ = min. 6.3 mm d ₃ = max. 19.0 mm
Ring cable lug cover		3RT1946-4EA1

¹⁾ The following ring cable lugs are approved for achieving the required clearances and creepage distances:

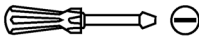
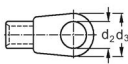
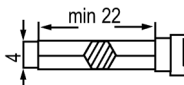
- For applications according to IEC 60947-1:
 - DIN 46237 (with insulating sleeve)
 - JIS CS805 type RAV (with insulating sleeve)
 - JIS CS805 type RAP (with insulating sleeve)
- For applications according to UL 508:
 - DIN 46 234 (without insulating sleeve)
 - DIN 46225 (without insulating sleeve)
 - JIS CS805 (without insulating sleeve)

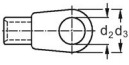
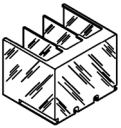
A shrink-on sleeve must be used to insulate ring cable lugs without an insulating sleeve. The following conditions must be met:

- Operating temperature: -55 °C to +155 °C
- UL 224 approved
- Flame-protected





⚠ DANGER

Hazardous voltage.
Will cause death or serious injury.
Only use approved ring cable lugs to meet the required clearances and creepage distances.



9.2 Conductor cross-sections

Table 9- 30 Main conductors of size S6 with M8 screws

Contactors with bus connection		
Connecting bars (M8 x 25)		2 x 15 x 4 mm M8 x 25
Tightening torque		10.0 ... 14.0 Nm
Finely stranded with cable lug		2 x (25 ... 120) mm ² ¹⁾ 2 x (AWG 4 to 250 kcmil)
Stranded with cable lug		2 x (16 ... 95) mm ² ¹⁾ 2 x AWG 6 to 3/0
AWG		4 ... 250 kcmil



1) When connecting cable lugs according to DIN 46235 with conductor cross-sections of 95 mm² and more, the 3RT1956-4EA1 terminal cover must be used to ensure phase clearance.

Table 9- 31 Main conductors of size S10 / S12 with M10 screws

Contactors with bus connection		
Connecting bars (M10 x 30)		2 x 25 x (..) mm M10 x 30
Tightening torque		14.0 ... 24.0 Nm
Finely stranded with cable lug		2 x (70 ... 240) mm ² ¹⁾ 2 x (AWG 2/0 to 500 kcmil)
Stranded with cable lug		22 x (50 ... 240) mm ² ¹⁾ 2 x AWG 1/0 to 500 kcmil



1) When connecting cable lugs in accordance with DIN 46234 for conductor cross-sections from 240 mm², as well as DIN 46235 for cable cross-sections from 185 ², use the 3RT1966-4EA1 terminal cover to ensure phase clearance.

Table 9- 32 Main conductors of size S6 with M8 screws

Electronic overload relay with busbar connection		
Connecting bars (M8 x 25)		2 x 15 x 4
Tightening torque		10.0 ... 14.0 Nm
Finely stranded with cable lug		16 ... 95 mm ² ¹⁾
Stranded with cable lug		25 ... 120 mm ² ¹⁾
AWG		4 ... 250 kcmil

1) When connecting cable lugs according to DIN 46235 with conductor cross-sections of 95 mm² and more, the 3RT1956-4EA1 terminal cover must be used to ensure phase clearance.

Table 9- 33 Main conductors of size S10 / S12 with M10 screws

Electronic overload relay with busbar connection		
Connecting bars (M10 x 30)		2 x 25 x 6
Tightening torque		14.0 ... 24.0 Nm
Finely stranded with cable lug		50 ... 240 mm ² ¹⁾
Stranded with cable lug		70 ... 240 mm ² ¹⁾
AWG		2/0 ... 500 kcmil

1) When connecting cable lugs in accordance with DIN 46234 for conductor cross-sections from 240 mm², as well as DIN 46235 for cable cross-sections from 185 ², use the 3RT1966-4EA1 terminal cover to ensure phase clearance.

9.3 CAx data

You can find the CAx data in the Siemens Industry Online Support (<https://support.industry.siemens.com/cs/ww/en/ps/16027/td>).

1. Enter the full article number of the desired device in the "Product" field, and confirm with the Enter key.
2. Click the "CAx data link.

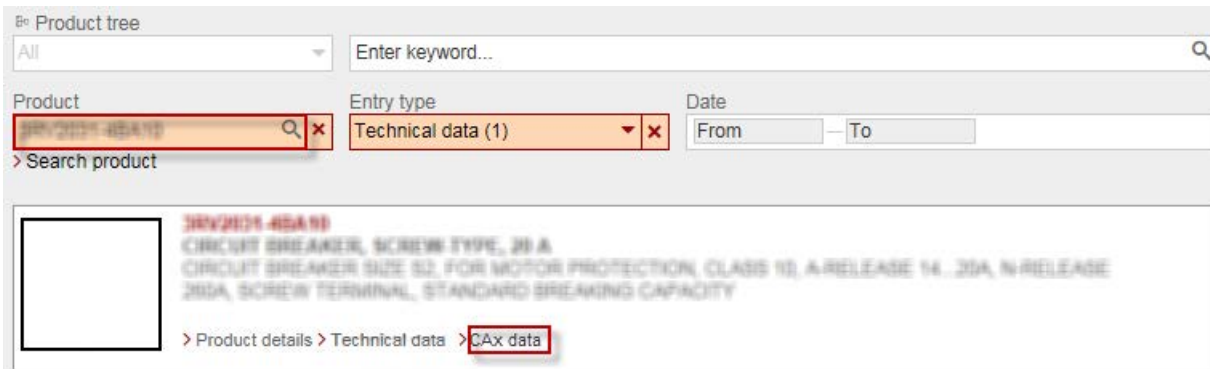

Glossary

3-phase busbar

The 3-phase busbar enables several motor starter protectors or compact starters to be fed using a single infeed terminal.

8US busbar adapter

The 8US busbar adapter enables motor starter protectors, load feeders, or compact starters to be mechanically fastened and electrically connected to a busbar system.

a release

Short designation for "inverse-time delayed overload release".

Adapter for screw mounting

The adapters for screw mounting enable you to mount the compact starter on a level surface.

Approvals

Approval of switching devices and switchgear in accordance with national standards, some of which must be met on a mandatory basis, which exist in addition to "IEC", "CENELEC", and "CEE" guidelines, for example. So, the North American market (the USA and Canada) requires UL or CSA approvals, for instance. There is also an obligation to label the equipment accordingly, i.e. the approval mark must be inscribed on the device itself.

AS-Interface

The AS-Interface is an open, international standard in accordance with EN 50295 and IEC 62026-2 for process communication and field communication. Leading manufacturers of actuators and sensors worldwide support AS-Interface. The electrical and mechanical specifications of the AS-Interface Association are disclosed to interested companies.

Assembly method

SIRIUS offers maximum flexibility in terms of configuration. The system components can be assembled as feeders or mounted separately.

Auxiliary switch block for compact starter

Optional auxiliary switch block in the following versions: 2 NO contacts, 2 NC contacts or 1 NO contact plus 1 NC contact.

AWG (American Wire Gauge)

A standard measure for conductors used in the USA, which is assigned to a specific cross-sectional area of a conductor or wire. Each AWG number represents a jump of 26% in the cross-sectional area. The thicker the wire, the smaller the AWG number.

Basic module

Function modules consist of at least one basic module, which can be expanded by adding coupling modules as required. The basic module contains the control logic and, for star-delta (wye-delta) modules, the time setting for starting in star operation and a 10-pin connector into which the plug connectors on the coupling modules are inserted.

Bypass operation

Once the motor has been started up correctly, the thyristors in the SIRIUS soft starters are subject to fully advanced control, meaning that the whole line voltage is applied to the motor terminals. As the motor voltage does not have to be controlled during operation, the thyristors are bridged by integral bypass contacts that are rated for AC1 current. This minimizes the waste heat generated during continuous operation (which is caused by the thyristors' power loss), and prevents the switching device's environment from heating up.

CLASS (time)

See "Tripping class".

Closing power

The power input of the magnet coils of a contactor, which is required to set the magnet system in motion. In AC operation, this power input is usually higher than the holding power. When running SIRIUS contactors in DC operation, the closing power is equal to the holding power.

Connection system

SIRIUS has the right connection system for every environment: screw terminals, spring-loaded terminals, or ring cable lug connection.

Contactors

Switching device with just one neutral position, usually without a mechanical lock, which is not activated manually and which, under normal circuit conditions, including an operating overload, can switch on, conduct and switch off currents. Contactors are primarily used where high switching frequencies are involved. A distinction is made between: contactors for switching motors (motor switches) and contactor relays for control purposes.

Contact assembly for star-delta (wye-delta) start

Contact assembly which switches the motor to the star circuit during startup (1/3 of the starting current compared to delta startup) and back to the delta circuit after a certain period of time. Contact assemblies for star-delta (wye-delta) start are used in situations where a high starting current has to be avoided in order to reduce the effects on the mechanical components or the line.

Control kit

Tool for closing the main contacts manually by means of the handle.

Coupling module

Function modules consist of at least one basic module, which can be expanded by adding coupling modules as required. The coupling module includes one NO contact and one 10-pole connecting cable with a plug connector for insertion into the coupling module and basic module; it is used for the mutual interlocking of star and delta operation. The communication-capable version transfers signals to the other contactors and implements the electrical interlock (reversing/star-delta (wye-delta) start) - in this case, there is no integrated connecting cable.

Current limiting for soft starters

The SIRIUS 3RW40 soft starter measures the phase current (motor current) continuously with the help of integrated current transformers. The motor current that flows during the startup process can be actively limited by means of the soft starter. The current limiting function takes priority over the voltage ramp function. As soon as a parameterizable current limit is reached, in other words, the voltage ramp is interrupted and the motor is started with the current limiting value until it has started up successfully.

The current limiting function is always active with SIRIUS 3RW40 soft starters. If the current limiting potentiometer is set to the right endstop (maximum), the starting current is limited to five times the set rated motor current.

The current limiting value is set to the current required during startup as a factor of the rated motor current. Since the starting current is asymmetrical, the set current corresponds to the arithmetic mean value for the three phases.

Current monitoring relays

Current monitoring relays are used to monitor motors or other loads for underload and overload. The level of current permits extensive conclusions to be drawn about the powered process or plant, e.g. a torn belt, pump no-load operation, tool wear, hoist overload or blockage. With multi-phase monitoring, the phase sequence, phase failure, or fault current can be monitored too. If the current measured values are outside the defined range, an alert will be issued or a disconnection initiated either immediately or with a time delay.

Current setting range (of an overcurrent release)

The range between the lowest and highest current value to which the release can be set.

Door-coupling rotary operating mechanism

Door-coupling rotary operating mechanisms enable motor starter protectors/circuit breakers and compact starters to be operated with the control cabinet doors closed.

Electrical interlock

Electrical dependency between switching devices, implemented by means of circuitry. Auxiliary contacts or auxiliary switches are usually used to realize an electrical interlock.

Explosion protection

Prerequisite for using electrical equipment in hazardous areas conforming to DIN EN 50014 (VDE 0170/0171). In terms of explosion protection, you must ensure that equipment which may generate explosive arcs (plasma) during operation is enclosed in a flameproof casing. This means that, although the potentially explosive mixture could penetrate the enclosure, if an explosion were to occur inside it then no explosive flame could escape.

Function module

Different function modules are used for:

- Direct-on-line start
- Reversing start
- Star-delta (wye-delta) start

Function modules are also available in communication-capable versions with AS-i or IO-Link, in order to establish a connection to a higher-level control system.

Function module for direct-on-line start

This function module is used for the time-delayed switching of contactors.

Function module for reversing start

The function module for reversing start is used to control a reversing starter. The version without a fieldbus interface consists of bridge modules, while the version for AS-Interface or IO-Link comprises basic and coupling modules. In all three cases, the electrical interlocks for protection in both directions are already in place.

Function module for star-delta (wye-delta) start

The function module for star-delta (wye-delta) start is used for toggling between star (wye) and delta operation. It consists of one basic module and two coupling modules. The electrical interlocks are already in place in the modules.

Generalized phase control for soft starters

With SIRIUS soft starters, the rms value of the motor voltage is increased (from a settable starting voltage) to the rated motor voltage within a definable start time by means of the phase control of two anti-parallel thyristor pairs.

The motor current changes in proportion to the voltage applied to the motor. As a result, the starting current is reduced by the factor of this voltage.

There is a quadratic relationship between the torque and the voltage applied to the motor. As a result, the starting torque is reduced quadratically in relation to this voltage.

Heavy-duty starting

Heavy starting exists if a motor requires more than 10 to 15 seconds from being switched on to reaching its rated speed on account of its special load conditions. When heavy starting exists, the load torque of the machine to be driven is greater during startup than in rated operation. It takes a long time for the rated speed to be reached because large centrifugal masses need to be accelerated (e.g. on rolling mills, centrifuges). Special overload relays (heavy-duty starting relays, solid-state overload relays) or thermistor motor protection devices must be used to protect heavy-starting motors.

Heavy-duty starting for soft starters

Assuming that certain conditions and constraints apply, the SIRIUS soft starter size must be at least one performance class higher than the motor rating for heavy-duty starting (CLASS 20 startup). The tables in the relevant product manual provide sample set values and device dimensions.

Holding power

The power input of the magnet coils of a contactor, which depends on the continuously consumed current, and which is required to hold the magnet system in the ON state.

Infeed system for 3RA6

The infeed system for 3RA6 enables several compact starters to be fed using an infeed system designed to modular principles with retained wiring.

Instantaneous short-circuit release

Release for a motor starter protector/circuit breaker, which provides short-circuit protection for the downstream load or the cable. The instantaneous short-circuit release must disable all poles of the motor starter protector/circuit breaker (acc. to UL) instantaneously or with a short-time delay in the event of a short circuit.

Intrinsic device protection for soft starters

The SIRIUS 3RW40 soft starter features integrated intrinsic device protection, which protects the thyristors from thermal overload. This is achieved by measuring the current via transformers in the three phases on the one hand, and also by measuring the temperature via thermal sensors on the thyristor heat sink. If the internal, permanently set trip value is exceeded, the soft starter will switch off automatically.

Inverse-time delayed overload release (a release)

A thermal overload release which works with a time delay that decreases as the current rises.

IO-Link

IO-Link is a new communication standard for sensors and actuators - defined by the PROFIBUS User Organization (PNO). The IO-Link technology is based on a point-to-point connection of the sensors and actuators to the control. Therefore, this technology is not a bus system, but an enhanced version of a classic point-to-point connection. In addition to the cyclic operating data, comprehensive parameters and diagnostics data are transferred for the connected sensors and actuators. The connection system consists of a three-pole standard cable or three single wires.

Leakage current

If semiconductors are used to control the current flow, no galvanic isolation can take place within the device. This means that, even when the supply is disconnected, if a connected load is present then a small residual current, known as the leakage current, will still flow.

Low-voltage switchgear and controlgear combination

A switchgear and controlgear combination is a grouping of one or more low-voltage switching devices with associated equipment for controlling, measuring, and indicating, together with the associated protective devices and control devices. The manufacturer is responsible for all assembly work, including all internal electrical and mechanical connections and structural parts.

Main switch

Every industrial machine which falls under the scope of DIN EN 60204 Part 1 (VDE 0113, Part 1) must be equipped with a main switch which disconnects all electrical equipment from the network while cleaning, maintenance, and repair work is being carried out, as well as during long periods of downtime. Usually a switch which can be operated by hand is stipulated in order to prevent electrical or mechanical hazards. The main switch can also function as an EMERGENCY-STOP device.

It must meet the following requirements:

1. Externally accessible handle
2. Only one "Off" position and one "On" position with allocated stops
3. Two positions labeled "0" and "I"
4. Lockable "Off" position
5. Cover for the power supply terminals to protect against accidental contact
6. The switching capacity must correspond to AC-23 for motor switches and AC-22 for load-break switches (utilization category).
7. Switch position displayed automatically

Mirror contacts of power contactors

A mirror contact is an NC contact, which cannot be closed at the same time as an NO main contact (according to EN 60947-5-1, Annex F).

Modular system

The SIRIUS modular system offers all the functions and devices needed for switching, starting, protecting, and monitoring motors and systems. In other words, it provides a modular range of standard components, which are perfectly matched to one another, can be combined really easily, and use the same accessories.

Motor protection

Protection for three-phase motors against overload and short circuit, i.e. protection for the winding insulation against impermissible heating.

Motor starter protectors

Generally a latch-operated switch, which can switch on, conduct, and switch off currents in the circuit under normal operating conditions; it can also switch on the current up to the point of a short circuit under specified operating conditions that are not normal, conduct current for a defined period, and interrupt it too.

n release

Short designation for "instantaneous electromagnetic overcurrent release".

OFF-delay

The time interval effected by a timing relay or timer (on contactors, for example) between a switch-off command being issued and the contacts of the timing relay or timer reaching their initial position.

ON time in %

The duty ratio ON time in % is the ratio between the load duration and the cycle duration for loads that are frequently switched on and off.

Operating range

Range within which the operating voltage of a switching device (e.g. a contactor) may deviate from the rated operating voltage without impairing the operational reliability of the switching device (e.g. contactor drop-out).

Overload relays

Inverse-time delayed relay which responds to an overload in accordance with a time-current characteristic, thus protecting the switching device and load from overloads.

Overload release

Overcurrent release that provides protection against overload.

Phase loss sensitivity

A product feature which enables the protective device to respond even when a three-phase induction motor is running in single-phase operation, before the motor sustains thermal damage (DIN VDE 0660 Part 102).

Polarity balancing for soft starters

In two-phase controlled SIRIUS 3RW30 and 3RW40 soft starters, the current that results from the superimposition of the two controlled phases flows in the uncontrolled phase. The main advantages of two-phase control include the more compact size compared to a three-phase version and the lower hardware costs.

The occurrence of DC components, caused by the phase control and the overlapping of phase currents, is a negative physical effect of two-phase control during the startup process that can mean a louder noise is produced by the motor. The "Polarity Balancing" control principle was developed and patented by SIEMENS to prevent these DC components during starting.

"Polarity Balancing" effectively eliminates these DC components during the startup phase. It allows the motor to be started up with a constant speed, torque, and current rise. The acoustic quality of the startup process comes very close to that of a three-phase controlled startup. This is made possible by the continuous dynamic alignment and balancing of current half-waves with different polarities during motor startup.

Positively driven contacts for contactor relays

Positively driven contact elements are a combination of "n" NO contacts and "m" NC contacts, which are designed such that they cannot be closed simultaneously (EN 60947-5- 1, Annex L).

Preferred wiring for star-delta (wye-delta) starters

According to the preferred wiring, the motor terminals of a motor running in the clockwise direction are connected correctly if phase L1 is connected to motor terminals U1 and V2, L2 to V1 and W2, and L3 to W1 and U2. This order should be observed during installation in order to keep the switchover current peaks in a motor running in the clockwise direction as low as possible during switchover from star to delta operation.

Protective technology

A basic distinction can be made between two current-based protective technologies: thermal and electronic protection. Motor starter protectors and thermal overload relays provide protection by means of bimetal releases, while solid-state overload relays, 3RW40 soft starters, and 3RA6 compact starters offer protection via electronic means. Electronic protective devices not only offer a significantly lower level of power loss, they also provide a wide setting range of 1:4 and, as a result, much less variance than thermal releases. The SIRIUS modular system offers the right solution for every type of switching technology.

Ramp time

With SIRIUS soft starters, the length of the set ramp time determines the time taken to increase the motor voltage from the parameterized starting voltage to the line voltage. This influences the motor's acceleration torque, which drives the load during the startup process. A longer ramp time results in a lower acceleration torque as the motor is started up. The startup is slower and smoother as a result. The ramp time should be long enough for the motor to reach its nominal speed. If the time selected is too short, in other words if the ramp time ends before the motor has started up successfully, a very high starting current that can even equal the direct starting current at the same speed occurs at this instant.

Ramp-down time

The "Ramp-down time" potentiometer on the SIRIUS 3RW40 soft starter allows you to specify how long power should still be supplied to the motor after the ON command has been removed. The torque generated in the motor is reduced by means of a voltage ramp function within this ramp-down time and the application stops smoothly.

Ramp-up detection for soft starters

The SIRIUS 3RW40 soft starter is equipped with an integrated ramp-up detection function. If it detects a motor startup, the motor voltage is immediately increased to 100% of the line voltage. The internal bypass contacts close and the thyristors are bridged.

Rated conditional short-circuit current I_q

The guaranteed short-circuit breaking capacity of switchgear assemblies and load feeders, also called "rated conditional short-circuit current".

Rated data for the control circuit

The most important rated data for the control circuit in terms of selecting a switching device (e.g. a contactor) are the rated control supply voltage U_s (voltage of the coil terminal) with the associated frequency (e.g. 50 Hz), as well as the power input of the coil (closing power and holding power) in the case of contactors, for example.

Rated data for the main circuit

The most important rated data for the main circuit in terms of selecting a switching device (e.g. a contactor) are the rated operational current I_e (current specified by the conditions of use) or the rated power (motor power), as well as the corresponding rated voltage U_e .

Rated impulse withstand voltage (U_{imp})

Peak value of a surge voltage with a defined waveform and polarity, which can be applied to the device under specified test conditions without the device failing and to which the clearances refer. The rated impulse withstand voltage of a device must be equal to or greater than the transient overvoltages which occur in the network on which the device is being used.

Rated insulation voltage U_i

Voltage value which specifies the insulation strength of the switching device or accessory and to which the insulation tests and the creepages and clearances refer. The maximum rated operational voltage must not be greater than the rated insulation voltage under any circumstances.

Rated service short-circuit breaking capacity I_{cs}

Compared to the rated ultimate short-circuit breaking capacity I_{cu} , the test conditions here are stricter and the short-circuit current is usually lower. Determined using test sequence II, operating sequence O-t-CO-t-CO (O = open, t = time, CO = close-open). The function of the motor starter protector/circuit breaker must remain unrestricted following this test.

Rated short-circuit breaking capacity I_{cn}

According to IEC 60947-2 and DIN EN 60947-2, the rated short-circuit breaking capacity of a motor starter protector/circuit breaker is the value of the short-circuit current, which it can switch off at the rated operational voltage, rated frequency, and specified power factor (or specified time constant). The value of the prospective current (for alternating current, the rms value of the AC component) specified by the manufacturer applies. For AC motor starter protectors/circuit breakers, the rated short-circuit breaking capacity must be independent of the magnitude of the DC (direct-current) component. The rated short-circuit breaking capacity also ensures that the motor starter protector/circuit breaker can switch off every current up to the rated short-circuit breaking capacity in the event of a line-frequency recovery voltage with 110% of the rated operational voltage.

This applies

- For alternating current, at every value of the power factor, but not lower than the value defined in the relevant test specification
- For direct current, if no other specifications have been made to the contrary by the manufacturer, with every time constant, but not greater than the value defined in the relevant test specification.

The short-circuit breaking capacity does not apply in the event of a line-frequency recovery voltage above 110% of the rated operational voltage.

Rated ultimate short-circuit breaking capacity I_{cu}

Maximum short-circuit current I_k (limit value of the rated short-circuit breaking capacity), which can switch the motor starter protector/circuit breaker off under specific conditions. Determined using test sequence III, operating sequence O-t-CO (O = open, t = time, CO = close-open). The function of the motor starter protector/circuit breaker may be restricted following this test.

Recovery time

When a protection function in a switching device has been tripped (e.g. motor starter protector, soft starter, overload relay, or current monitoring relay), the motor cannot be restarted until a recovery time has elapsed. The length of the recovery time will vary, depending on the cause of the error. For more information, refer to the corresponding product documentation.

Response delay

The response delay is the time from when you start to enter a command until the first contact connection is made, at the contactor, for example.

RoHS

EC Directive 2002/95/EC concerning the restriction of the use of certain hazardous substances in electrical and electronic equipment regulates the use of hazardous substances in devices and components. The English abbreviation RoHS is used to refer to this directive: (Restriction of the use of certain hazardous substances), as well as all related measures for implementing it into national legislation.

Service life

Period of time for which the switching device will work properly under normal operating conditions. This is specified as the number of operating cycles, the electrical durability (e.g. contact erosion), and the mechanical durability (e.g. operating cycles without load).

Short-circuit strength

This is the resistivity of a switching device in the closed state, along with its components (e.g. releases), or a complete switchgear, to the electrodynamic (dynamic strength) and thermal (thermal strength) stresses which arise in the event of a short circuit. The characteristic for the dynamic stress is the rated peak withstand current, which is the maximum instantaneous value of the short-circuit current. The characteristic for the thermal stress of the short-circuit current is the root-mean-square value of the short-circuit current throughout its duration.

SIL (Safety Integrity Level)

Discrete level (one of three possibilities) for defining safety integrity specifications of safety-related control functions. Safety integrity level 3 is the highest possible level, level 1 the lowest.

Soft ramp-down

The same principle as that used for soft starting is applied during the ramp-down process. This ensures that the torque generated in the motor is reduced gradually, so that the application can ramp down smoothly.

In "soft ramp-down" mode, the natural stop process of the load is decelerated. The function is used when the load must be prevented from stopping abruptly. This is typically the case in applications with a low mass inertia or a high counter-torque.

Soft start

Since the motor voltage is controlled (phase control) by an electronic soft starter during the startup process, the consumed starting current and the starting torque generated in the motor are also controlled.

Soft starter

This is a motor starter which reduces the starting torque (starting torque, break loose torque) and the starting current of the motor in order to decrease the vibrations experienced by the driven machine and to prevent current peaks in the network. The starting torque is reduced because the supply voltage is initially set to a value lower than the rated voltage of the motor (the starting torque is proportional to the square of the voltage applied). The terminal voltage can be increased as soon as the motor starts to run. Classic ways of reducing the terminal voltage are star-delta (wye-delta) start, startup via resistors in the stator, and startup with an auto-transformer, for example. The use of solid-state motor controllers with switched thyristor circuits is becoming more and more prevalent as a way of controlling the terminal voltage on squirrel-cage motors. See also "Soft starting" and "Soft ramp-down".

Space above the arc chute

When a switching device is being operated, particularly when highly inductive load currents or short-circuit currents are being switched off, the ionized gases generated by the arc are pressed out of the openings in the arc chute. In order to ensure that the concentration of these ionized gases does not reach a hazardous level, a specific clearance must be provided above or in front of the device. This space above the arc chute is defined by the manufacturer (usually on the dimension drawings) and depends on whether exposed live conductors (e.g. busbars), conductive structural components, and insulating partitions can be found on the switching device. Arc chute attachments can be mounted to larger motor starter protectors in order to reduce the required clearance and therefore the space required in the control cabinet. No space is required above the arc chute for vacuum circuit breakers and vacuum contactors, since the arc will not escape from the vacuum chute and no ionized gases will be released.

Star-delta (wye-delta) starter

See "Contactor assembly for star-delta (wye-delta) start".

Starting current

Three-phase induction motors have a high direct starting current I_{starting} . Depending on the motor type, this current can be between three and fifteen times as high as the rated operational current. Seven or eight times the rated motor current can be assumed as a typical value.

Starting torque

The starting torque and the breakdown torque can usually be assumed to be between two and four times the rated torque. From the point of view of the load machine, this means that the starting and acceleration forces exert a higher mechanical load on the machine and the product being conveyed compared to nominal operation.

Starting voltage

The starting voltage determines the starting torque of the motor for SIRIUS soft starters. A lower starting voltage results in a lower starting torque and a lower starting current. The starting voltage selected must be sufficiently high to ensure that motor starts up smoothly as soon as the start command is received by the soft starter.

Switching frequency

Number of operating cycles per time unit (e.g. 15 operations per hour).

The maximum permissible switching frequency must not be exceeded because the SIRIUS soft starters could be damaged due to thermal overloading. The switching frequency of SIRIUS soft starters size S0 to S3 can be increased by installing an optional additional fan.

Switching technology

A basic distinction can be made between two types of switching technology: On the electromechanical side, there are contactors, contactor assemblies, and compact starters which can be used to implement solutions for direct-on-line start, reversing start, and star-delta (wye-delta) start. Frequent switching or reversing, soft starting, and soft ramp-down, on the other hand, are initiated using electronic switching devices: solid-state switching devices and soft starters. The SIRIUS modular system offers the right solution for every type of switching technology.

Temperature compensation

With inverse-time delayed (thermal) overload releases and relays, not only the current, but also the ambient temperature has an effect on the tripping time. An additional bimetal strip, which is not heated up by the current, can be used to compensate for the influence of the ambient temperature. If solid-state overload relays are used, electronic compensation is possible.

Terminals for "Self Protected Combination Motor Controller Type E"

The terminals conform to the clearances and creepage distances stipulated by UL 508 (Type E).

Thermistor motor protection

Motor protection provided by temperature sensors (PTC sensors) integrated in the windings. These sensors monitor the winding temperature directly.

Time-delayed auxiliary switch

Module which can be integrated into various combinations of auxiliary switches and can usually be retrofitted to a switching device too.

Timing relay

Switching device with electronic time delay, which opens or closes contacts after a specified period of time has elapsed.

Tripping characteristic curve

The tripping characteristic (curve) is the graphical representation of the relationship between the tripping time and the controlling variable. The time-current diagram can be used to find out, for example, how long it will take for the release or the tripping relay to respond at a particular current.

Tripping class (CLASS)

The tripping class of a current-dependent overload relay (including thermal and solid-state overload relays and releases) specifies the maximum tripping time from cold at a particular load. The tripping class number (e.g. CLASS 10, 20, 30) represents the maximum permissible tripping time in seconds when the relay is subjected to a symmetrical 3-pole load from cold with 7.2 times the current setting (IEC 947-4-1; DIN VDE 0660 Part 107). Tripping classes 20 and 30 are used for protecting the motor under heavy-duty starting conditions, for example.

Tripping current (of an overload release)

The current value at which a release trips within a certain time.

Two-phase control

With solid-state switching devices like soft starters or solid-state contactors, two out of three active phases are controlled by means of semiconductors. For example, SIRIUS 3RW30 and 3RW40 soft starters feature two anti-parallel thyristors in each of phases L1 and L3. Phase L2 is an uncontrolled phase, which is routed through the starter via a copper link and connected directly to the corresponding output terminal.

Types of coordination

The standard DIN EN 60947-4-1 (VDE 0660 Part 102) or IEC 947-4-1 distinguishes between two types of coordination, which are referred to as coordination type "1" and coordination type "2". Any short circuits that occur are cleared safely in both types of coordination. The only differences are in the extent of the damage sustained by the device following a short circuit.

Utilization category

According to DIN EN 60947-4-1, the application area of and the load applied to power contactors can be identified by looking at the specified utilization category in conjunction with the specified rated operational current or the motor power and the rated voltage. An example is utilization category AC-3 for starting and switching off squirrel-cage motors.

Voltage ramp

The SIRIUS 3RW30 and 3RW40 soft starters achieve soft starting by means of a voltage ramp. The motor terminal voltage is increased from a parameterizable starting voltage up to the line voltage within a definable start time.

Index

3

- 3D model, 11
- 3RA21 / 3RA22 load feeders, 155
- 3RA6 compact starters, 161
- 3RB24 electronic overload relays for IO-Link, 131
- 3RR2 current monitoring relays, 136
- 3RW44 soft starter, 108

A

- Accessories
 - Motor starter protector, 116
- Advantages
 - Motor starter protector, 115
 - Overload relay, 129
- App
 - Siemens Industry Online Support, 12
- Applications, 107
 - Contactors, 75
 - Function modules for mounting on contactors, 98
 - Load feeders, 158
 - Motor starter protector, 114
 - Overload relay, 128
 - Solid-state switching devices, 105
- Approvals, 18
- AS-Interface, 42, 53
- Assembly, 36, 65
- Auxiliary switches
 - Load feeders, 154
- Auxiliary switches (function modules for mounting on contactors)
 - Solid-state time-delay, 97

B

- Basic knowledge, 9
- Basic module
 - Function modules for mounting on contactors, 100
- Bus connection system, 35

C

- CAX data, 11, 198
- Certifications, 18

- Characteristics, 18
- Combinations, 38, 95, 159
- Compact starters, 36
- Conductor cross-sections, 181
- Connection, 39
- Connection methods
 - Solid-state switching devices, 104
- Connection systems, 35
 - Function modules for mounting on contactors, 97
 - Motor starter protector, 112
 - Overload relay, 125
- Contactor assemblies for star-delta (wye-delta) start, 69
 - Load feeders, 156
- Contactor relays, 69
- Contactors, 32, 39, 76, 85
- Coupling module
 - Function modules for mounting on contactors, 100
- Current monitoring relay, 40
- Current monitoring relays, 39
- Customer benefits, 65

D

- Device concept, 133
- Device versions
 - Contactors, 73
 - Function modules for mounting on contactors, 97
 - Load feeders, 151
 - Motor starter protector, 113
 - Overload relay, 126
 - Solid-state switching devices, 103
- Diagnostics data, 43, 44
- Dimension drawings, 11
- Direct-on-line start, 32, 91, 95
 - Function modules for mounting on contactors, 97, 98
- Disposal, 13

E

- Energy efficiency, 59, 59, 60, 62, 63
- Environment, 58
- EPLAN macros, 11

- F**
 - Features
 - Compact starter, 162
 - Function module for IO-Link, 92
 - Function module for star-delta (wye-delta) start
 - Control circuit wiring, 100
 - Pre-assembled, 100
 - Function modules, 21, 43, 89, 90
 - Function overview, 150
 - Functional overview, 147

- I**
 - Identification of energy flows, 59
 - Infeed systems, 119, 120, 166
 - Insulating stop, 178
 - Interlock
 - Electrical, 100
 - IO-Link, 42, 44

- L**
 - Link module, 38, 160, 177
 - Load feeders, 36, 38
 - Combination of individual devices, 156

- M**
 - Modular system, 21, 26, 30, 32, 37, 59, 59, 60, 62, 63
 - Monitoring, 21
 - Motor starter protector, 38, 111

- O**
 - Overload protection, 40
 - Overload relays, 39

- P**
 - Power contactor, 69, 71
 - Power loss, 59, 59, 60, 62, 63
 - Product data sheet, 198
 - PROFIBUS, 108
 - Properties
 - Solid-state overload relay for IO-Link, 132
 - Protective functions, 40

- R**
 - Recycling, 13
 - Reversing contactor assemblies, 69
 - Load feeders, 156
 - Reversing start, 32, 91, 95
 - Ring cable lug connection system, 35, 35, 180, 194

- S**
 - Safety applications, 58
 - Safety rules, 15
 - Screw mounting, 169
 - Screwdriver, 37
 - Screw-type connection system, 35, 173, 181
 - Selection criteria, 107
 - SIRIUS 3RU thermal overload relays / SIRIUS 3RB electronic overload relays, 122
 - Snap-on mounting, 170
 - Soft start, 32
 - Soft starter, 33, 106
 - Solid-state contactors, 103, 104, 105
 - Solid-state reversing contactors, 103, 104, 105
 - Solid-state switching devices, 32, 39, 102
 - Instantaneous switching, 103, 104
 - Spring-loaded connection system, 35, 174, 192
 - Standards, 17
 - Star-delta (wye-delta) start, 32, 91, 95
 - Function modules for mounting on contactors, 97, 99
 - Switch position, 43
 - Switching
 - Motorized load, 103, 105
 - Resistive load, 103
 - System components, 36, 133
 - System monitoring, 65, 66

- T**
 - Technical Assistance, 13
 - Technology, 34
 - Test certificates, 18
 - Three-phase induction motor, 108
 - Through-hole technology, 35, 191, 191, 191
 - Thyristor pair, 32, 33
 - Timing relays, 97
 - Function modules for mounting on contactors, 100
 - Tool, 37
 - Types of coordination, 153
 - Load feeders, 152

U

Ultra-heavy-duty starting, 108

Utilization categories

 Contactors, 75

V

Vacuum contactor, 71

Validity, 9

