

Altivar Process ATV600

Application Note

Multi-Masters Booster Control with Pressure Feedback

01/2017



The information provided in this documentation contains general descriptions and/or technical characteristics of the performance of the products contained herein. This documentation is not intended as a substitute for and is not to be used for determining suitability or reliability of these products for specific user applications. It is the duty of any such user or integrator to perform the appropriate and complete risk analysis, evaluation and testing of the products with respect to the relevant specific application or use thereof. Neither Schneider Electric nor any of its affiliates or subsidiaries shall be responsible or liable for misuse of the information contained herein. If you have any suggestions for improvements or amendments or have found errors in this publication, please notify us.

No part of this document may be reproduced in any form or by any means, electronic or mechanical, including photocopying, without express written permission of Schneider Electric.

All pertinent state, regional, and local safety regulations must be observed when installing and using this product. For reasons of safety and to help ensure compliance with documented system data, only the manufacturer must perform repairs to components.

When devices are used for applications with technical safety requirements, the relevant instructions must be followed. Failure to use Schneider Electric software or approved software with our hardware products may result in injury, harm, or improper operating results.

Failure to observe this information can result in injury or equipment damage.

© 2017 Schneider Electric. All rights reserved.

Table of Contents



Safety Information	4
About the Book	8
Part I Overview	11
Introduction	12
Booster Control	13
Multi-Pump System Architectures	14
Booster Control Overview	15
Booster Control with Service Continuity	18
Part II Application Description.....	19
Application Description.....	20
Wiring.....	21
Part III Prerequisites	22
Application Selection.....	23
Motor Configuration.....	24
High and Low Speed Configuration.....	26
System Units Customization	27
Ethernet Settings.....	28
Part IV MultiPump Configuration	30
Pump System Architectures	31
MultiDrive Link Configuration	32
Part V Booster Control Configuration	34
Booster Control Activation.....	35
Type of Control Configuration	36
Stage / Destage Condition	37
PID Controller.....	38
Start the Application	40
Part VI Additional Parameters.....	42
MultiDrive Link - Optional Wiring	43
MultiDrive Link – Errors & Warning Handling	45
System Architecture – Pumps Configuration.....	47
System Architecture – Pump Cycling Parameters.....	48
Part VII Parameters Table	49
Parameters Table.....	50

Safety Information



Important Information

NOTICE

Read these instructions carefully, and look at the equipment to become familiar with the device before trying to install, operate, or maintain it. The following special messages may appear throughout this documentation or on the equipment to inform of potential hazards or to call attention to information that clarifies or simplifies a procedure.



The addition of this symbol to a Danger safety label indicates that an electrical hazard exists, which will result in personal injury if the instructions are not followed.



This is the safety alert symbol. It is used to alert you to potential personal injury hazards. Obey all safety messages that follow this symbol to avoid possible injury or death.

DANGER

DANGER indicates an imminently hazardous situation which, if not avoided, **results in** death or serious injury.

WARNING

WARNING indicates a potentially hazardous situation which, if not avoided, **can result in** death or serious injury.

CAUTION

CAUTION indicates a potentially hazardous situation which, if not avoided, **can result in** minor or moderate injury.

NOTICE

NOTICE is used to address practices not related to physical injury.

PLEASE NOTE

Electrical equipment should be installed, operated, serviced, and maintained only by qualified personnel. No responsibility is assumed by Schneider Electric for any consequences arising out of the use of this material.

A qualified person is one who has skills and knowledge related to the construction and operation of electrical equipment and its installation, and has received safety training to recognize and avoid the hazards involved.

Intended Use

This product is a drive for three-phase synchronous and asynchronous motors and intended for industrial use according to this manual. The product may only be used in compliance with all applicable safety regulations and directives, the specified requirements and the technical data. Prior to using the product, you must perform a risk assessment in view of the planned application. Based on the results, the appropriate safety measures must be implemented. Since the product is used as a component in an entire system, you must ensure the safety of persons by means of the design of this entire system (for example, machine design). Any use other than the use explicitly permitted is prohibited and can result in hazards. Electrical equipment should be installed, operated, serviced, and maintained only by qualified personnel.

Product Related Information

Read and understand these instructions before performing any procedure with this drive.

DANGER

HAZARD OF ELECTRIC SHOCK, EXPLOSION OR ARC FLASH

- Only appropriately trained persons who are familiar with and understand the contents of this manual and all other pertinent product documentation and who have received safety training to recognize and avoid hazards involved are authorized to work on and with this drive system. Installation, adjustment, repair and maintenance must be performed by qualified personnel.
- The system integrator is responsible for compliance with all local and national electrical code requirements as well as all other applicable regulations with respect to grounding of all equipment.
- Many components of the product, including the printed circuit boards, operate with mains voltage. Do not touch.
- Only use properly rated, electrically insulated tools and measuring equipment.
- Do not touch unshielded components or terminals with voltage present.
- Motors can generate voltage when the shaft is rotated. Prior to performing any type of work on the drive system, block the motor shaft to prevent rotation.
- AC voltage can couple voltage to unused conductors in the motor cable. Insulate both ends of unused conductors of the motor cable.
- Do not short across the DC bus terminals or the DC bus capacitors or the braking resistor terminals.
- Before performing work on the drive system:
 - Disconnect all power, including external control power that may be present.
 - Place a **Do Not Turn On** label on all power switches related to the drive system.
 - Lock all power switches in the open position.
 - Wait 15 minutes to allow the DC bus capacitors to discharge.
 - Follow the instructions given in the chapter "Verifying the Absence of Voltage" in the installation manual of the product.
- Before applying voltage to the drive system:
 - Verify that the work has been completed and that the entire installation cannot cause hazards.
 - If the mains input terminals and the motor output terminals have been grounded and short-circuited, remove the ground and the short circuits on the mains input terminals and the motor output terminals.
 - Verify proper grounding of all equipment.
 - Verify that all protective equipment such as covers, doors, grids is installed and/or closed

Failure to follow these instructions will result in death or serious injury.

Drive systems may perform unexpected movements because of incorrect wiring, incorrect settings, incorrect data or other errors.

WARNING

UNANTICIPATED EQUIPMENT OPERATION

- Carefully install the wiring in accordance with the EMC requirements.
- Do not operate the product with unknown or unsuitable settings or data.
- Perform a comprehensive commissioning test.

Failure to follow these instructions can result in death, serious injury, or equipment damage.

Damaged products or accessories may cause electric shock or unanticipated equipment operation.

DANGER

ELECTRIC SHOCK OR UNANTICIPATED EQUIPMENT OPERATION

Do not use damaged products or accessories.

Failure to follow these instructions will result in death or serious injury.

Contact your local Schneider Electric sales office if you detect any damage whatsoever.

WARNING

LOSS OF CONTROL

- The designer of any control scheme must consider the potential failure modes of control paths and, for critical control functions, provide a means to achieve a safe state during and after a path failure. Examples of critical control functions are emergency stop, overtravel stop, power outage and restart.
- Separate or redundant control paths must be provided for critical control functions.
- System control paths may include communication links. Consideration must be given to the implications of unanticipated transmission delays or failures of the link.
- Observe all accident prevention regulations and local safety guidelines (1).
- Each implementation of the product must be individually and thoroughly tested for proper operation before being placed into service.

Failure to follow these instructions can result in death, serious injury, or equipment damage.

(1) For USA: Additional information, refer to NEMA ICS 1.1 (latest edition), Safety Guidelines for the Application, Installation, and Maintenance of Solid State Control and to NEMA ICS 7.1 (latest edition), Safety Standards for Construction and Guide for Selection, Installation and Operation of Adjustable-Speed Drive Systems.

This equipment has been designed to operate outside of any hazardous location. Only install this equipment in zones known to be free of hazardous atmosphere.

DANGER

POTENTIAL FOR EXPLOSION

Install and use this equipment in non-hazardous locations only.

Failure to follow these instructions will result in death or serious injury.

Machines, controllers, and related equipment are usually integrated into networks. Unauthorized persons and malware may gain access to the machine as well as to other devices on the network/fieldbus of the machine and connected networks via insufficiently secure access to software and networks.

 **WARNING**

UNAUTHORIZED ACCESS TO THE MACHINE VIA SOFTWARE AND NETWORKS

- In your hazard and risk analysis, consider all hazards that result from access to and operation on the network/fieldbus and develop an appropriate cyber security concept.
- Verify that the hardware infrastructure and the software infrastructure into which the machine is integrated as well as all organizational measures and rules covering access to this infrastructure consider the results of the hazard and risk analysis and are implemented according to best practices and standards covering IT security and cyber security (such as: ISO/IEC 27000 series, Common Criteria for Information Technology Security Evaluation, ISO/IEC 15408, IEC 62351, ISA/IEC 62443, NIST Cybersecurity Framework, Information Security Forum - Standard of Good Practice for Information Security).
- Verify the effectiveness of your IT security and cyber security systems using appropriate, proven methods.

Failure to follow these instructions can result in death, serious injury, or equipment damage.

About the Book



At a Glance

Document Scope

The purpose of this document is to show how to configure a Multi-Drives Booster Control with Service Continuity.

The document is structured in six main parts which are:

- Overview: this part gives an approach of Altivar Process ATV600 capabilities inside process industry.
- Application Description: this part provides the application and architecture selected for this application note.
- Prerequisites: this part provides the minimum steps to achieve before starting the Booster Control with Service Continuity commissioning.
- MultiPump Configuration: this part provides the steps to configure the Multi-Drives Architecture and MultiDrive Link feature.
- Booster Control with Service Continuity: this part provides the minimum steps to achieve to configure the Booster Control application
- Additional Parameters: this part provides details on parameters which allow advanced configuration of the Booster Control application.

NOTE: Read and understand this document and all related documents (see below) before installing, operating, or maintaining your drive.

Validity Note

This document is valid for the Altivar Process ATV600 drives.

The technical characteristics of the devices described in this document also appear online. To access this information online:

Step	Action
1	Go to Schneider Electric home page www.schneider-electric.com
2	In the Search box type the reference of a product or the name of a product range. <ul style="list-style-type: none">• Do not include blank spaces in the model number/product range.• To get information on grouping similar modules, use asterisks (*).
3	If you entered a reference, go to the Product Datasheets search results and click on the reference that interests you. If you entered the name of a product range, go to the Product Ranges search results and click on the product range that interests you
4	If more than one reference appears in the Products search results, click on the reference that interests you
5	Depending on the size of your screen, you may need to scroll down to see the data sheet.
6	To save or print a data sheet as a .pdf file, click Download XXX product datasheet.

The characteristics that are presented in this manual should be the same as those characteristics that appear online. In line with our policy of constant improvement, we may revise content over time to improve clarity and accuracy. If you see a difference between the manual and online information, use the online information as your reference.

Related Documents

Use your tablet or your PC to quickly access detailed and comprehensive information on all our products on www.schneider-electric.com

The internet site provides the information you need for products and solutions

- The whole catalog for detailed characteristics and selection guides
- The CAD files to help design your installation, available in over 20 different file formats
- All software and firmware to maintain your installation up to date
- A large quantity of White Papers, Environment documents, Application solutions, Specifications... to gain a better understanding of our electrical systems and equipment or automation
- And finally all the User Guides related to your drive, listed below:

Title of Documentation	Reference Number
ATV600 Getting Started	EAV63253 (English), EAV63254 (French), EAV63255 (German), EAV63256 (Spanish), EAV64310 (Italian), EAV64298 (Chinese)
ATV600 Getting Started Annex (SCCR)	EAV64300 (English)
ATV630, ATV650 Installation Manual	EAV64301 (English), EAV64302 (French), EAV64306 (German), EAV64307 (Spanish), EAV63257 (Italian), EAV64317 (Chinese)
ATV630, ATV650 Programming Manual	EAV64318 (English), EAV64320 (French), EAV64321 (German), EAV64322 (Spanish), EAV64323 (Italian), EAV64324 (Chinese)
ATV600 Modbus Serial Link Manual	EAV64325 (English)
ATV600 Ethernet Manual (Embedded)	EAV64327 (English)
ATV600 Ethernet IP - Modbus TCP Manual (VW3A3720, VW3A3721)	EAV64328 (English)
ATV600 PROFIBUS DP manual (VW3A3607)	EAV64329 (English)
ATV600 DeviceNet manual (VW3A3609)	EAV64330 (English)
ATV600 PROFINET manual (VW3A3627)	EAV64331 (English)
ATV600 CANopen manual (VW3A3608, 618, 628)	EAV64333 (English)
ATV600 Communication Parameters	EAV64332 (English)
ATV600 Safety Function manual	EAV64334 (English)
Altivar Process Drive Systems - Installation manual	NHA37119 (English), NHA37121 (French), NHA37118 (German), NHA37122 (Spanish), NHA37123 (Italian), NHA37130 (Chinese), NHA37124 (Dutch), NHA37126 (Polish), NHA37127 (Portuguese), NHA37128 (Russian), NHA37129 (Turkish)
ATV660 Handbook	NHA37111 (English), NHA37110 (German)
ATV680 Handbook	NHA37113 (English), NHA37112 (German)
SoMove : FDT	SoMove_FDT (English, French, German, Spanish, Italian, Chinese)
Altivar Process ATV600 : DTM	ATV6xx DTM Library EN (English), ATV6xx DTM Lang FR (French), ATV6xx DTM Lang DE (German), ATV6xx DTM Lang SP (Spanish), ATV6xx DTM Lang IT (Italian), ATV6xx DTM Lang CN (Chinese)

You can download these technical publications and other technical information from our website at <http://download.schneider-electric.com>

Terminology

The technical terms, terminology, and the corresponding descriptions in this manual normally use the terms or definitions in the relevant standards.

In the area of drive systems this includes, but is not limited to, terms such as **error, error message, failure, fault, fault reset, protection, safe state, safety function, warning, warning message**, and so on.

Among others, these standards include:

- IEC 61800 series: Adjustable speed electrical power drive systems
- IEC 61508 Ed.2 series: Functional safety of electrical/electronic/programmable electronic safety-related
- EN 954-1 Safety of machinery - Safety related parts of control systems
- EN ISO 13849-1 & 2 Safety of machinery - Safety related parts of control systems.
- IEC 61158 series: Industrial communication networks - Fieldbus specifications
- IEC 61784 series: Industrial communication networks - Profiles
- IEC 60204-1: Safety of machinery - Electrical equipment of machines – Part 1: General requirements

In addition, the term **zone of operation** is used in conjunction with the description of specific hazards, and is defined as it is for a **hazard zone** or **danger zone** in the EC Machinery Directive (2006/42/EC) and in ISO 12100-1.

Part I

Overview

What is in This Part?

This part contains the following topics:

Introduction.....	12
Booster Control	13
Multi-Pump System Architectures	14
Booster Control Overview	15
Booster Control with Service Continuity	18

Introduction

About This Application Note

The goal of this Application Note is to provide a commissioning procedure to configure a Multi-Drives Booster Control application with Service Continuity.

This Application Note does not cover all the use cases and cannot be consider as a substitution of the ATV600 Programming Manual.

For more details about the Booster Control function embedded on Altivar Process ATV600 drives, refer to the ATV600 Programming Manual (EAV64318).

Booster Control

About Booster Control

Booster Control is used to maintain a constant pressure at the outlet by varying the speed of the pumps. Altivar Process ATV600 drives allow these pumps to have an optimized consumption of the power and at the same time provide optimized monitoring features.

Booster Control Applications

Booster Control is used in several pumping processes.

Applications example for Water and Waste Water, where Booster Control can be used depending of the Booster Control mode:

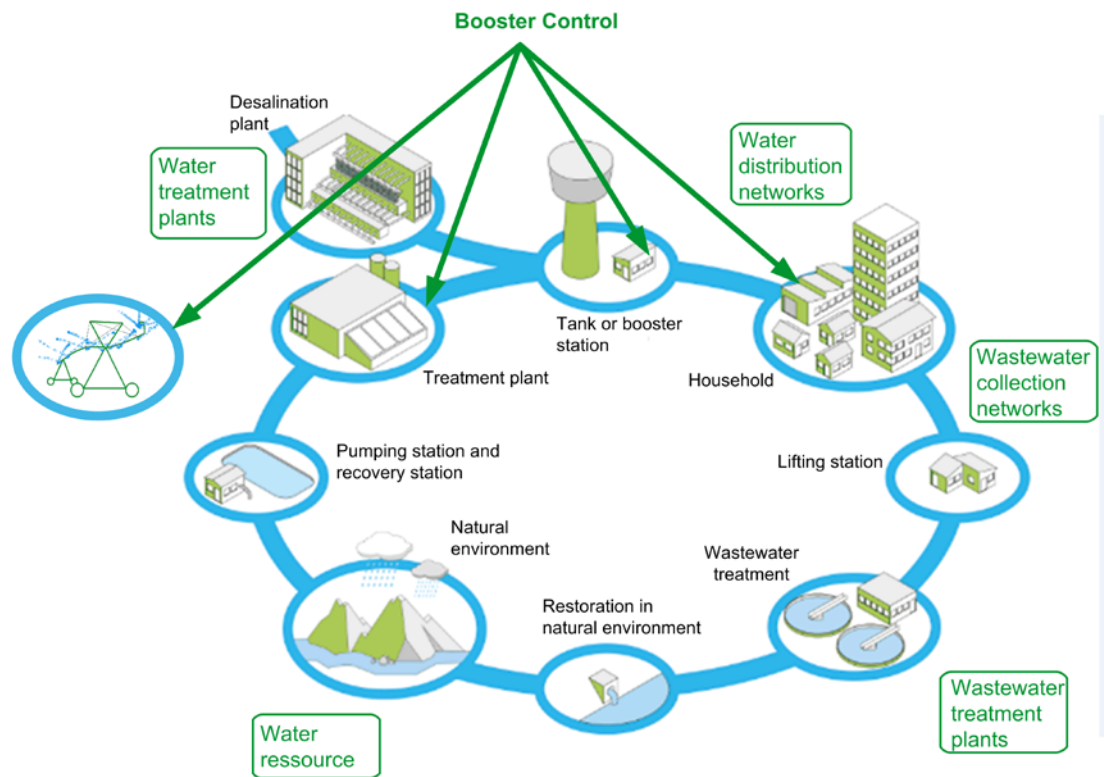

Multi-Pump System Architectures

About Multi-Pump System Architectures

Several Multi-Pump System Architectures exist in process industry. Altivar Process ATV600 drives can be used in several architectures.

Supported Multi-Pump Architectures

The following table shows the Altivar Process ATV600 capabilities for integration into Multi-Pump Architectures:

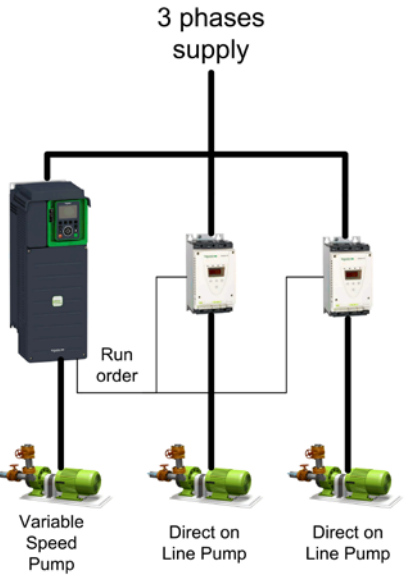
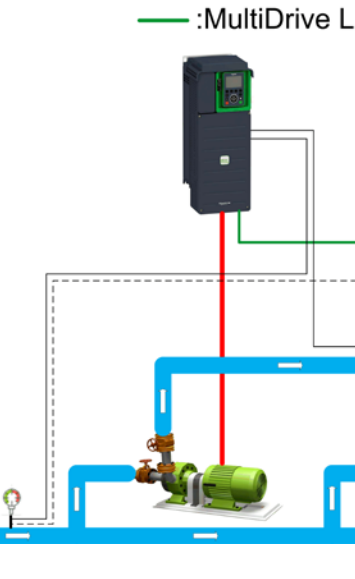
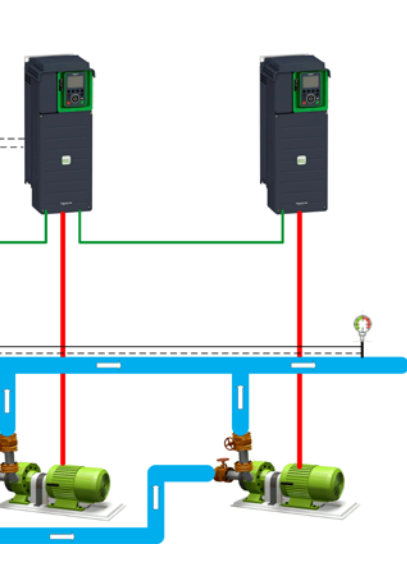
Single Drive	Multiple Drives	Multiple Drives & Service continuity
 <p>3 phases supply</p> <p>Run order</p> <p>Variable Speed Pump</p> <p>Direct on Line Pump</p> <p>Direct on Line Pump</p>	 <p>:MultiDrive Link</p>	
<p>This architecture can be found on simple installations.</p> <p>It provides basic control of the complete installation with a single drive.</p> <p>The Altivar Process ATV600 drive is able to control up to 5 direct on line (or Starter controlled) pumps in addition to the variable speed one.</p>	<p>This architecture can be found in advanced installations.</p> <p>It provides advanced control of the complete installation including the variable speed drives.</p> <p>The Master drive can control up to 5 Slaves through Multi-Drive Link technology.</p> <p>In Multiple Drives architecture, sensors are wired to the Master (continuous grey line in the schema)</p> <p>NOTE: Altivar Process ATV600 drives must be linked together through a Dual Port Ethernet fieldbus module (VW3A3721) plugged on each Altivar Process ATV600.</p>	<p>This architecture can be found in advanced installations where service continuity is needed.</p> <p>It provides advanced control of the complete installation including the variable speed drives.</p> <p>The drives on the installation can act as Master, Master or Slave, or Slave only through Multi-Drive Link technology.</p> <p>In Multiple Drives & Service Continuity, sensors are wired to the Master and to the Secondary Master (continuous and dotted grey line).</p> <p>NOTE: Altivar Process ATV600 drives must be linked together through a Dual Port Ethernet fieldbus module (VW3A3721) plugged on each Altivar Process ATV600.</p>

Booster Control Overview

Introduction

The aim of the booster control function is to maintain the desired pressure or flow at the outlet of the pumps according to the demand by:

- Managing the velocity of the variable speed pump connected to the drive.
- Staging / destaging the variable speed pumps or auxiliary fixed speed pumps.

Control Type

The type of control allows selecting which kind of process is used for the feedback, setpoint and other related values to control the PID

- Pressure: The system is based on pressure unit. This type of control is used for pressure regulation applications
- Flow: The system is based on flow unit. This type of control is used for flow regulation applications

Speed Control

Distributed Speed Control Mode

This speed control mode is available for **Multiple Drives architecture**.

The pumps will be staged and destaged one by one. The last staged pumps run at variable speed and other pumps run at fixed speed.

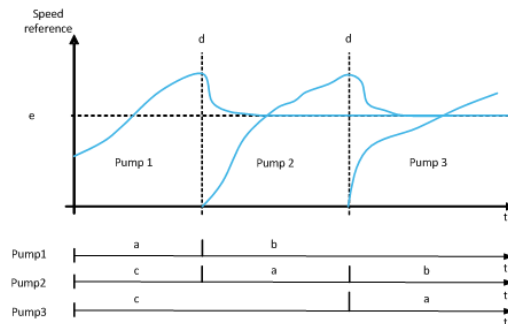

- a) Pump runs at variable speed
- b) Pump runs at fixed speed
- c) Pump stopped
- d) Pump staging
- e) Fixed reference frequency in distributed mode

Advanced Speed Control Mode

This speed control mode is available for **Multiple Drives architecture**.

The pumps are staged and destaged one by one. The pumps run at the same speed.

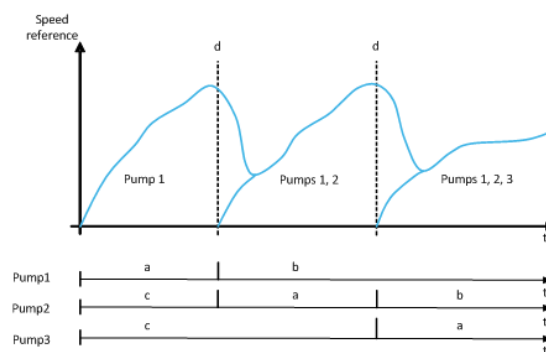

- a) Pump runs at variable speed
- b) Pump speed follows the last staged pump speed
- c) Pump stopped
- d) Pump staging

Traditional Control Mode

This speed control mode is available for **Single Drive architecture**.

There is only one variable speed pump. The variable speed is started first. Other pumps are staged / destaged one by one running at fixed speed, according to the need

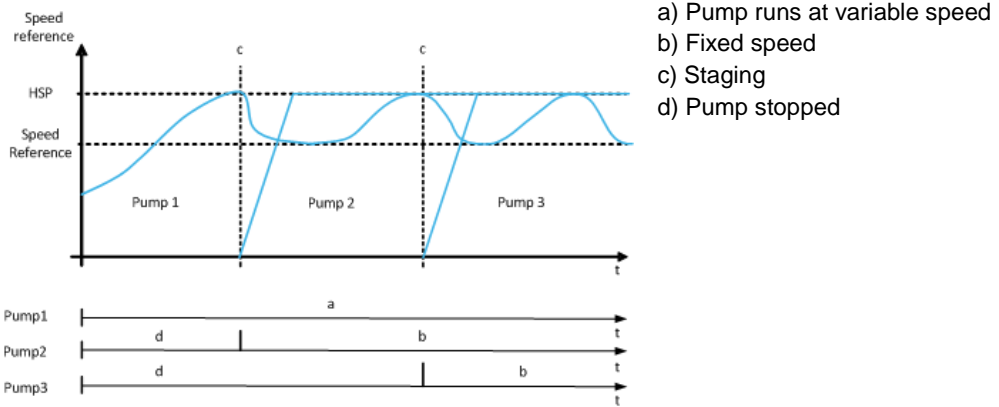

Stage / De-Stage Condition

It is possible to select the condition on which the pump is staged or de-staged:

- **Speed:** staging/destaging occurs according to conditions on the drive output frequency (Lead pump velocity).
- **Feedback:** staging/destaging occurs according to conditions on the outlet pressure feedback.
- **Speed + Flow:** staging occurs according to conditions on the drive output frequency (pump velocity), destaging occurs according to flow conditions.
- **Feedback + Flow:** staging occurs according to conditions on the outlet pressure feedback, destaging occurs according to flow conditions.
- **Energy Optimized:** staging/destaging occurs automatically to optimize the energy consumption of the system.

NOTE: Destage on speed or feedback is not possible because the pumps are running at the same speed.

Stage / Destage Condition	Control Type (PID Feedback)	Multiple Drives		Single Drive
		Distributed Control Mode	Advanced Control Mode	Traditional Control Mode
Stage and Destage on Speed	Pressure or Flow	✓		✓
Stage and Destage on PID Feedback	Pressure or Flow	✓		✓
Stage on Speed + Destage on Flow. ⁽¹⁾	Pressure		✓	
Stage on PID Feedback + Destage on Flow. ⁽¹⁾	Pressure		✓	
Stage / Destage according to best efficiency. ⁽²⁾	Pressure		✓	
NOTE :				
⁽¹⁾ : Based on installation flow or estimation				
⁽²⁾ : Need pump curves				

Stage / De-stage Method

Once the condition of stage / de-stage is reached, different methods can be applied to manage the transition of stage / de-stage:

- **Speed:** during stage/de-stage, PID controller is by-passed and a fixed reference frequency is applied.
- **Feedback:** outlet pressure remains regulated by the PID controller during stage/destage.
- **Advanced:** outlet pressure remains regulated by the PID controller during stage/destage and disturbances due to stage/de-stage are taken into account by the PID controller to reduce them.

Stage / De-stage Method	Control Type (PID Feedback)	Multiple Drives		Single Drive
		Distributed Control Mode	Advanced Control Mode	Traditional Control Mode
Speed	Pressure or Flow			✓
Feedback	Pressure or Flow	✓	✓	✓
Advanced (Feedback + feed forward)	Pressure			✓

Booster Control with Service Continuity

Service Continuity

In normal operation, drives are connected through a MultiDrive Link. One drive acts as Master and others drives act as Slaves. The configuration has to be done on each drive and has to be the same.

If one of the drives is not available, the Service Continuity allows to run the system. If the Master drive is not available, one of the Slaves will become the Master and the system keeps running.

The covered cases by the Service Continuity are:

- Non availability of a pump
- Non availability of a drive
- Non availability of a sensor

Advantages

- Energy saving
- Easy to configure
- Continuous operation on detected error

Part II

Application Description

What is in This Part?

This part contains the following topics:

Application Description.....	20
Wiring.....	21

Application Description

Introduction

This Application Note describes Booster Control application with 3 Altivar Process ATV600 variable speed drives in Service Continuity.

In this Application Note, there are 2 useful pumps, the 3rd pump is used as a spare pump.

The following parts of this Application Note describe the commissioning procedure for this architecture.

Application Description

The architecture used as example for this application note is the following:

- 3 Altivar Process ATV600 variable speed drives connected through MultiDrive Link.
- 3 Ethernet/IP / ModbusTCP fieldbus modules VW3A3721.
- 3 identical pumps and their associated electrical motors.
- 3 Pressure sensors at the system output.
- Pressure setpoint 6.5 bar.

The following figure shows the water architecture used in this application note:

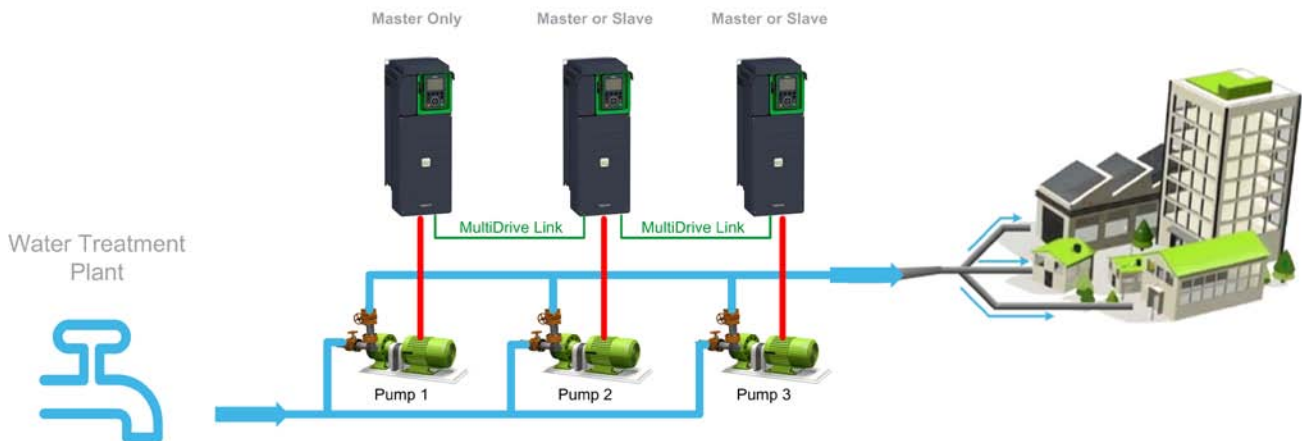

Wiring

What is in This Chapter?

The following part of this Application Note describes the wiring procedure for this architecture:

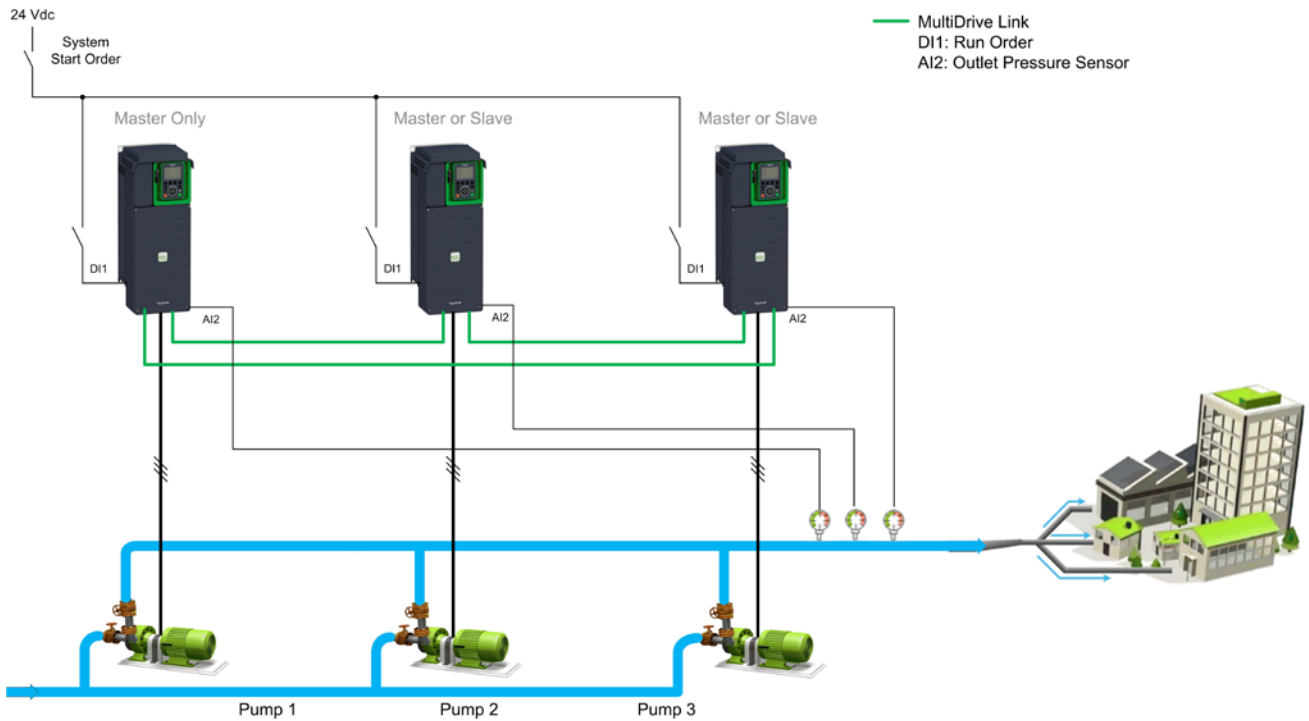

Part III

Prerequisites

Introduction

This part describes the initial steps to perform before configuring the Booster Control application.

The values of parameters given in this part correspond to the architecture selected for this Application Note.

NOTE: Settings may vary according to the architecture needs.

NOTE: Before starting the drive configuration, make sure that the drive is reset to factory settings.

What is in This Part?

This part contains the following topics:

Application Selection.....	23
Motor Configuration	24
High and Low Speed Configuration	26
System Units Customization	27
Ethernet Settings	28

Application Selection

Overview

The macro-configuration menu allows you to select the appropriate application functions.

This selection gives access to the dedicated functions and associated parameters.

Step by Step Configuration

The following table gives the step by step configuration of the Application Selection parameter:

Step	Action
1	<p>Go to [Complete Settings] C 5 E → [Macro Configuration] M C r menu</p> <p>The image shows two screenshots of a control interface. The left screenshot is the 'Main menu' with a wrench icon and a list of options: 2 Dashboard, 3 Diagnostics, 4 Display, 5 Complete settings (highlighted), and 6 Communication. The right screenshot is the 'Complete settings' menu with a list of options: 5.1 Macro Configuration (highlighted), 5.2 Motor parameters, 5.3 Define system units, 5.4 Sensors Assignment, and 5.5 Command and Refere.. Both screenshots show status indicators at the top: RDY, 0.0Hz, 0.00A, and Term, and a time of 11:23. A large black arrow points from the '5 Complete settings' option in the first menu to the '5.1 Macro Configuration' option in the second menu.</p>
2	<p>Set [Application Selection] A P P E to [Pump Booster Control] b o o 5 E</p> <p>The image shows a screenshot of the 'Application Selection' menu. At the top, it displays status indicators: RDY, 0.0Hz, 0.00A, and Term, along with a time of 18:03. Below this, the menu title 'Application Selection' is shown. The list of options includes: Generic Pump Control, Pump Level Control, Pump Booster Control (which has a checkmark next to it), and Generic Fan Control.</p>

Motor Configuration

Overview

The motor parameters have to be set to allow optimized motor control performances.

The parameters have to be entered according to the motor nameplate.

Step by Step Configuration

The following table gives the step by step configuration of the motor parameters:

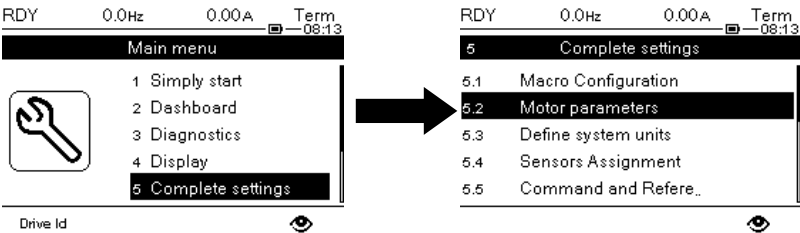
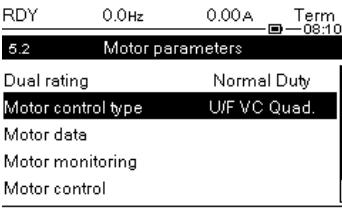
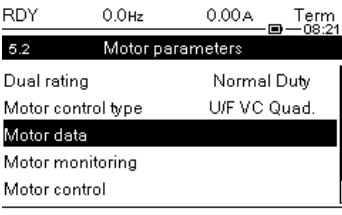
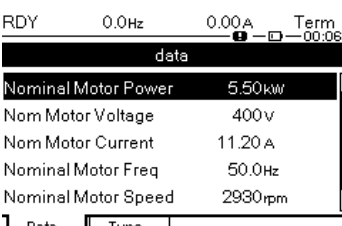
Step	Action
1	<p>Go to [Complete Settings] C S E - menu, [Motor parameters] P P A- submenu.</p> 
2	<p>Set [Motor Control Type] C E E to [U/F VC Quad.] U F Q.</p> 
3	<p>Go to [Motor data] P E d- submenu.</p> 
4	<p>On [Data] tab, set the motor parameters according to the motor nameplate:</p> <ul style="list-style-type: none"> • [Motor Standard] b F r : [50 Hz IEC] 50 • [Nominal Motor Power] n P r : 5.50 kW • [Nom Motor Voltage] u n S : 400 Vac • [Nom Motor Current] n C r : 11.20 A • [Nominal Motor Freq] F r S : 50.0 Hz • [Nominal Motor Speed] n S P : 2,930 rpm 

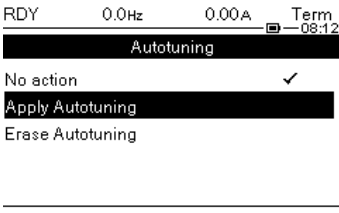
Step	Action
5	<p data-bbox="507 235 1257 264">On [Tune] tab, set [Autotuning] Run to [Apply Autotuning] YES.</p>  <p data-bbox="507 293 847 322">RDY 0.0Hz 0.00A Term 08.12</p> <p data-bbox="507 322 847 351">Autotuning</p> <p data-bbox="507 351 847 380">No action ✓</p> <p data-bbox="507 380 847 409">Apply Autotuning</p> <p data-bbox="507 409 847 439">Erase Autotuning</p> <hr data-bbox="507 488 847 495"/>
6	<p data-bbox="507 571 906 600">Verify the good direction of the motor</p> <p data-bbox="507 600 1010 629">If you need to modify the direction of the motor:</p> <ul data-bbox="507 629 1437 728" style="list-style-type: none"> <li data-bbox="507 629 751 658">• Modify the wiring, or <li data-bbox="507 658 1437 728">• Go to [Complete settings] CLT → [Motor parameters] PPA → [Motor control] drc, set [Output Ph Rotation] PHr to [ACB] ACb
7	<p data-bbox="507 741 1150 770">Repeat this procedure for each drive used in the application.</p>

High and Low Speed Configuration

Overview

It is advisable to configure a low speed of the pump to avoid no flow at the outlet of the pump.

Step by Step Configuration

The following table gives the step by step configuration of the high and low speed parameters:

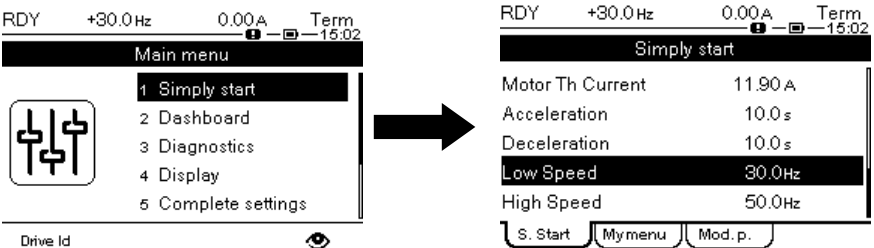
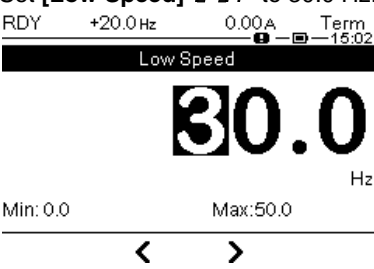
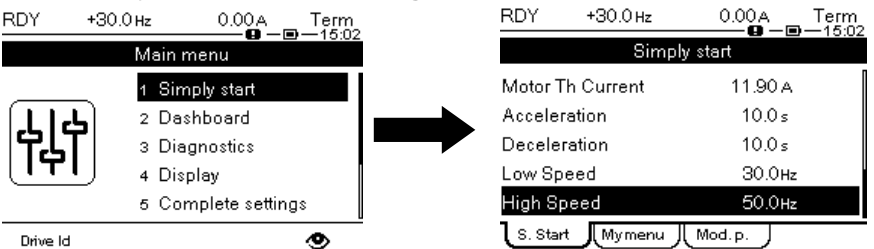
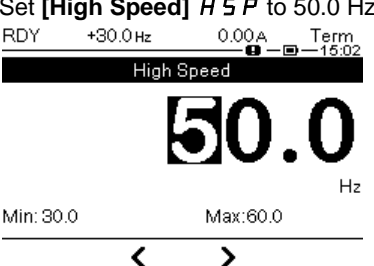
Step	Action
1	<p>Go to [Simply start] 5 4 5- menu, [Low Speed] L 5 P parameter</p>  <p>The first screenshot shows the 'Main menu' with 'Simply start' selected. The second screenshot shows the 'Simply start' parameter screen with 'Low Speed' set to 30.0 Hz. The 'High Speed' is set to 50.0 Hz. The status bar at the top shows 'RDY +30.0Hz 0.00A Term 15:02'.</p>
2	<p>Set [Low Speed] L 5 P to 30.0 Hz:</p>  <p>The screenshot shows the 'Low Speed' parameter screen with the value '30.0' displayed in large digits. Below the value, it says 'Hz'. The status bar at the top shows 'RDY +20.0Hz 0.00A Term 15:02'.</p>
3	<p>Go to [Simply start] 5 4 5- menu, [High Speed] H 5 P parameter</p>  <p>The first screenshot shows the 'Main menu' with 'Simply start' selected. The second screenshot shows the 'Simply start' parameter screen with 'High Speed' set to 50.0 Hz. The 'Low Speed' is set to 30.0 Hz. The status bar at the top shows 'RDY +30.0Hz 0.00A Term 15:02'.</p>
4	<p>Set [High Speed] H 5 P to 50.0 Hz:</p>  <p>The screenshot shows the 'High Speed' parameter screen with the value '50.0' displayed in large digits. Below the value, it says 'Hz'. The status bar at the top shows 'RDY +30.0Hz 0.00A Term 15:02'.</p>

System Units Customization

Overview

The Altivar Process ATV600 drive offers the possibility to have customized units for your application.

You will have to set your pressure unit according to your application.

This menu is used to customize the following units:

- Pressure
- Flow
- Temperature
- Currency

Step by Step Configuration

The following table gives the step by step configuration of the System Units:

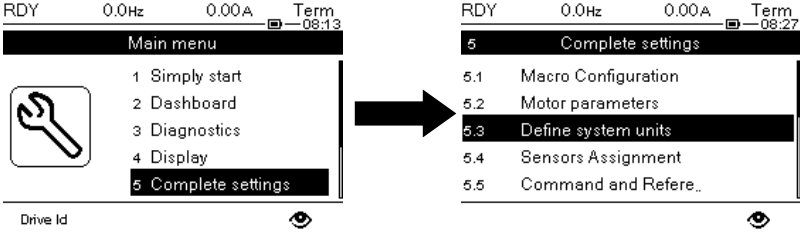
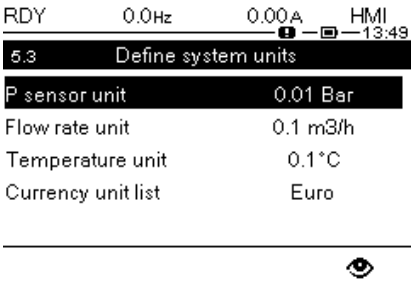
Step	Description
1	<p>Go to [Complete Settings] C 5 E - menu, [Define system units] S U C - submenu.</p>  <p>The image shows two screenshots of the HMI interface. The left screenshot shows the 'Main menu' with options: 1 Simply start, 2 Dashboard, 3 Diagnostics, 4 Display, and 5 Complete settings. The right screenshot shows the 'Complete settings' submenu with options: 5.1 Macro Configuration, 5.2 Motor parameters, 5.3 Define system units, 5.4 Sensors Assignment, and 5.5 Command and Refere.. An arrow points from the '5 Complete settings' option in the first screenshot to the '5.3 Define system units' option in the second screenshot.</p>
2	<p>Set the following parameters values:</p> <ul style="list-style-type: none"> • [P sensor unit] S U P r: [0.01 Bar] 0 0 1 b a r r • [Flow rate unit] S U F r: [0.1 m3/h] 0 1 m 3 h • [Temperature unit] S U T P: [0.1°C] 0 1 C • [Currency unit list] S U C u: [Euro] E u r o  <p>The image shows a screenshot of the '5.3 Define system units' HMI screen. The screen displays the following configuration: P sensor unit: 0.01 Bar, Flow rate unit: 0.1 m3/h, Temperature unit: 0.1°C, and Currency unit list: Euro.</p>

Ethernet Settings

Overview

MultiDrive Link feature of Altivar Process ATV600, equipped with VW3A3721 Ethernet modules, allows controlling the drives of your application using an Ethernet link between your drives.

The drives of an application have to be on the same Ethernet network.

NOTE: The Ethernet settings configuration can also be done automatically using a DHCP or a BOOTP server like a PLC.

Step by Step Configuration

The following table gives the step by step configuration for the Ethernet settings:

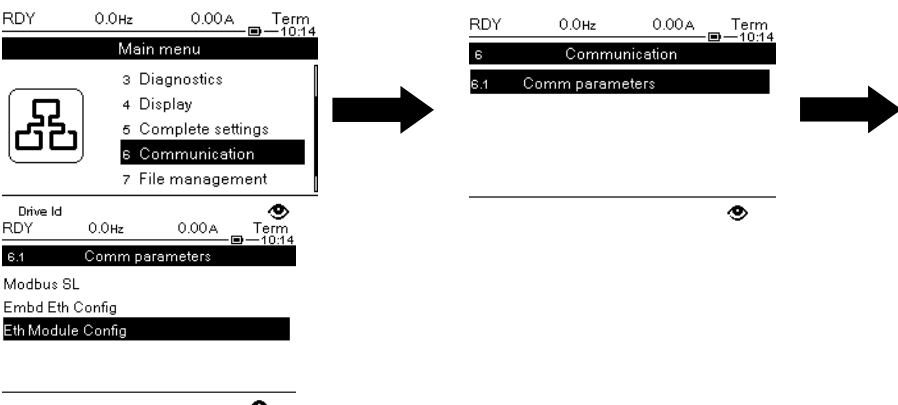
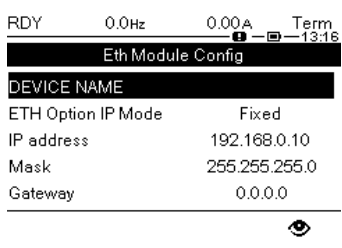
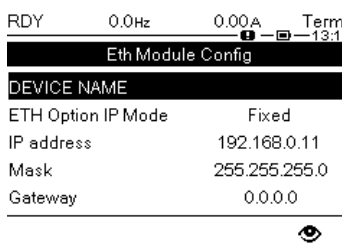
Step	Action
1	<p>Go to [Communication] \leftarrow \leftarrow \leftarrow [Comm parameters] \leftarrow \leftarrow \leftarrow [Eth Module Config] \leftarrow \leftarrow \leftarrow menu</p>  <p>The diagram shows three screenshots of the drive's menu system. The first screenshot shows the 'Main menu' with options: 3 Diagnostics, 4 Display, 5 Complete settings, 6 Communication, and 7 File management. An arrow points to the second screenshot, which shows the 'Communication' menu with option 6.1 Comm parameters. A second arrow points to the third screenshot, which shows the 'Comm parameters' menu with option 6.1 Eth Module Config. The top status bar of each screenshot displays 'RDY 0.0Hz 0.00A Term 10:14'.</p>
2	<p>On drive 1, configure the Ethernet settings:</p> <ul style="list-style-type: none"> Set [ETH Option IP Mode] , \leftarrow \leftarrow \leftarrow to [Fixed] \leftarrow \leftarrow \leftarrow, Set [IP address] to 192.168.0.10 Set [Mask] to 255.255.255.0 Set [Gateway] to 0.0.0.0  <p>The screenshot shows the 'Eth Module Config' screen for Drive 1. The top status bar displays 'RDY 0.0Hz 0.00A Term 13:16'. Below the title bar, there is a 'DEVICE NAME' field. The configuration parameters are: ETH Option IP Mode: Fixed, IP address: 192.168.0.10, Mask: 255.255.255.0, and Gateway: 0.0.0.0.</p>
3	<p>On drive 2, configure the Ethernet settings:</p> <ul style="list-style-type: none"> Set [ETH Option IP Mode] , \leftarrow \leftarrow \leftarrow to [Fixed] \leftarrow \leftarrow \leftarrow, Set [IP address] to 192.168.0.11 Set [Mask] to 255.255.255.0 Set [Gateway] to 0.0.0.0  <p>The screenshot shows the 'Eth Module Config' screen for Drive 2. The top status bar displays 'RDY 0.0Hz 0.00A Term 13:16'. Below the title bar, there is a 'DEVICE NAME' field. The configuration parameters are: ETH Option IP Mode: Fixed, IP address: 192.168.0.11, Mask: 255.255.255.0, and Gateway: 0.0.0.0.</p>

Step	Action
4	<p data-bbox="502 235 965 264">On drive 3, configure the Ethernet settings:</p> <ul data-bbox="502 302 949 465" style="list-style-type: none"> <li data-bbox="502 302 949 358">• Set [ETH Option IP Mode] to [Fixed] <li data-bbox="502 369 949 403">• Set [IP address] to 192.168.0.12 <li data-bbox="502 414 949 448">• Set [Mask] to 255.255.255.0 <li data-bbox="502 459 949 492">• Set [Gateway] to 0.0.0.0 <div data-bbox="1021 235 1396 488" style="border: 1px solid black; padding: 5px;"> <p data-bbox="1029 241 1388 268">RDY 0.0Hz 0.00A Term 13:16</p> <p data-bbox="1029 280 1388 302" style="text-align: center;">Eth Module Config</p> <hr/> <p data-bbox="1029 313 1388 336">DEVICE NAME</p> <p data-bbox="1029 347 1388 369">ETH Option IP Mode Fixed</p> <p data-bbox="1029 380 1388 403">IP address 192.168.0.12</p> <p data-bbox="1029 414 1388 436">Mask 255.255.255.0</p> <p data-bbox="1029 448 1388 470">Gateway 0.0.0.0</p> <hr/> <p data-bbox="1332 470 1364 492" style="text-align: right;">⏪</p> </div>
5	Restart the drives to take into account the Ethernet settings.

Part IV

MultiPump Configuration

Introduction

This part describes the steps to perform in order to use the MultiDrive Link feature of Altivar Process ATV600.

The values of parameters given in this part correspond to the Multi Drives architecture selected for this Application Note.

NOTE: Settings may vary according to the architecture needs.

What is in This Part?

This part contains the following topics:

Pump System Architectures.....	31
MultiDrive Link Configuration	32

Pump System Architectures

Overview

The Altivar Process ATV600 drive can be used in several pump architectures.

This menu is used to select and configure one of the following architectures:

- Single Drive: one Altivar Process ATV600 and up to 5 fixed speed pumps.
- Multi Drives: one Master Altivar Process ATV600 and up to 5 Slaves Altivar Process ATV600.
- Multi Masters: Up to 6 Altivar Process ATV600 that can act as Masters or Slaves.

In this Application Note, the selected architecture is Multi Masters.

Step by Step Configuration

The following table gives the step by step configuration for the selection of Pump System Architecture:

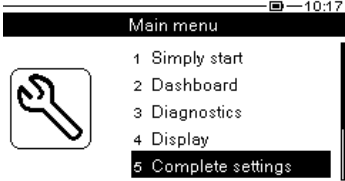
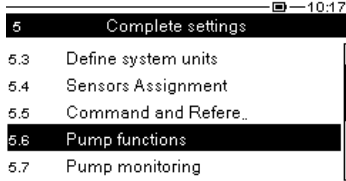
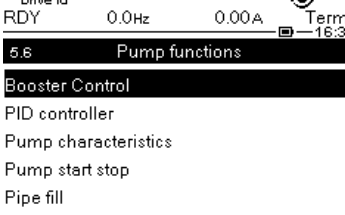
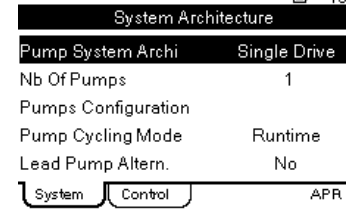
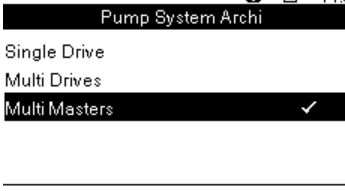
Step	Action
1	<p>Go to [Complete settings] <i>l 5 l</i> → [Pump functions] <i>P F l</i> → [Booster Control] <i>b 5 l</i> → [System architecture] <i>Π P 9</i> menu</p>     <p>RDY 0.0Hz 0.00A Term -10:17</p> <p>RDY 0.0Hz 0.00A Term -10:17</p> <p>RDY 0.0Hz 0.00A Term -16:31</p> <p>RDY 0.0Hz 0.00A Term -15:46</p>
2	<p>Set [Pump System Architecture] <i>Π P 5 A</i> to [Multi Masters] <i>n V 5 d r</i></p>  <p>RDY 0.0Hz 0.00A Term -14:38</p>

MultiDrive Link Configuration

Overview

The MultiDrive Link needs to be configured on each drive to define if the device in the application acts as Master or Slave.

In this Application Note, one drive acts as Master and the two other drives act as Master or Slave.

Master Step by Step Configuration

The following table gives the step by step configuration of the MultiDrive Link on **Primary Master**:

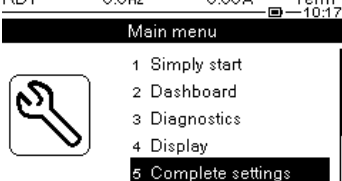
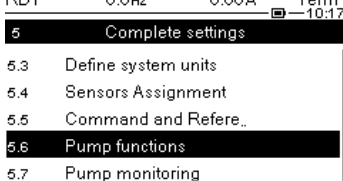
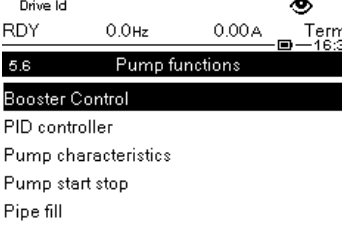
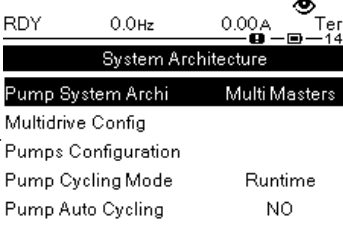
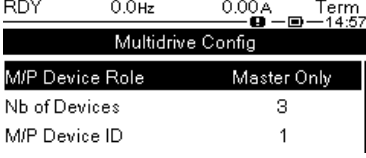
Step	Action
1	<p>Go to [Complete settings] C S E → [Pump functions] P F E → [Booster Control] b S E → [System architecture] P P 9 → [Multidrive Config] P P V C menu</p>    
2	<p>Configure the parameters:</p> <ul style="list-style-type: none"> • Set [M/P Device Role] P P D E to [Master Only] P A S E I, • Set [Nb of Devices] P P G n to 3, • Set [M/P Device ID] P G id to 1. 

Redundant Master Step by Step Configuration

The following table gives the step by step configuration of the MultiDrive Link on **Redundant Master**:

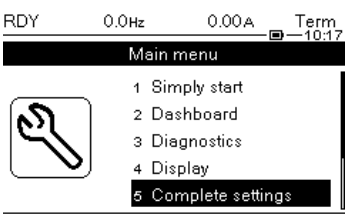
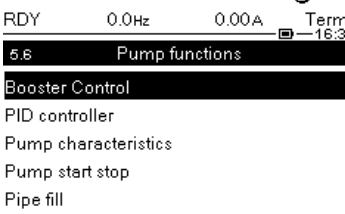
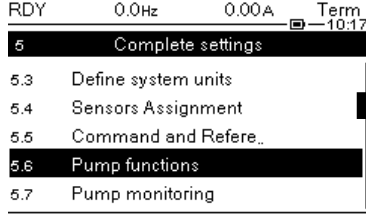
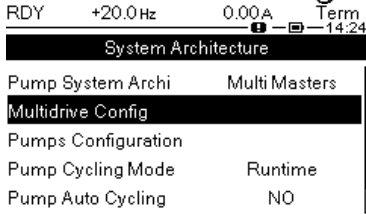
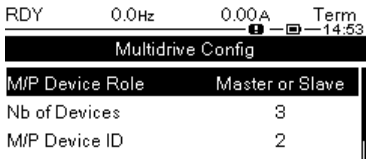
Step	Action
1	<p>Go to [Complete settings] <i>CLSE</i> → [Pump functions] <i>PFLE</i> → [Booster Control] <i>BSLE</i> → [System architecture] <i>PP9</i> → [Multidrive Config] <i>PPVL</i> menu</p>    
2	<p>Configure the parameters:</p> <ul style="list-style-type: none"> Set [M/P Device Role] <i>PPdE</i> to [Master or Slave] <i>PPSEZ</i>, Set [M/P Device ID] <i>PPid</i> to 2. 
3	Repeat the operation on the other Slaves by incrementing the [M/P Device ID] <i>PPid</i> value.

Part V

Booster Control Configuration

Introduction

This part describes the steps to perform in order to configure the Booster Control application.

The values of parameters given in this part correspond to the architecture selected for this Application Note.

NOTE: Settings may vary according to the architecture needs.

What is in This Part?

This part contains the following topics:

Booster Control Activation	35
Type of Control Configuration	36
Stage / Destage Condition	37
PID Controller	38
Start the Application.....	40

Booster Control Activation

Overview

This menu allows activating the Booster Control function on Altivar Process ATV600.

When you activate this function, a message informs you to configure the PID controller. This configuration will be done in a next part.

Step-by-Step Configuration

The following table gives the step by step configuration of the Booster Control Activation:

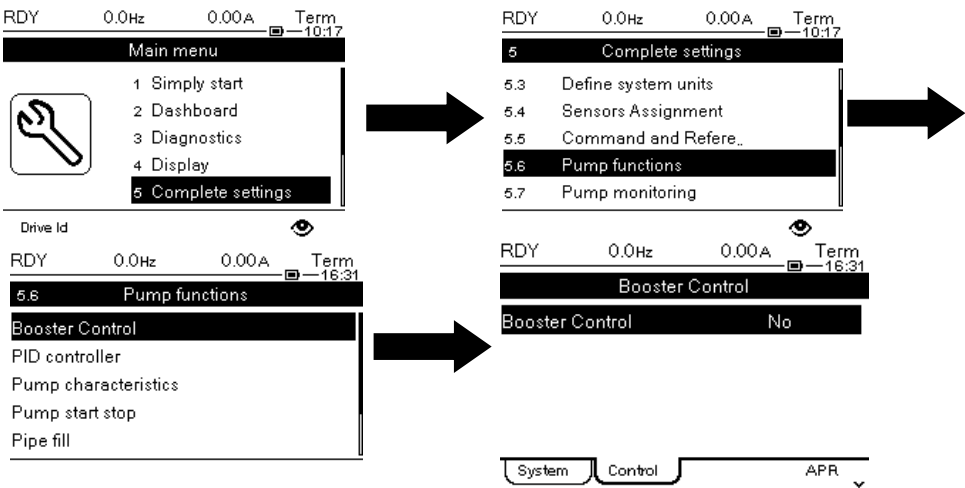
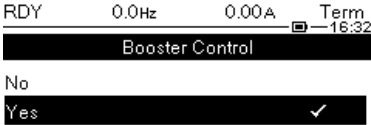
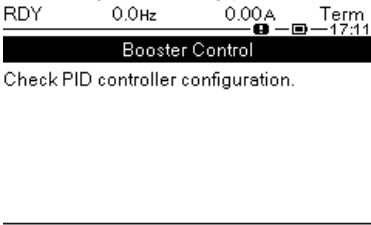
Step	Action
1	<p>Go to [Complete settings] C S E → [Pump functions] P F E → [Booster Control] b S C menu → [Booster Control] b S C tab:</p>  <p>RDY 0.0Hz 0.00A Term -10:17</p> <p>Main menu</p> <ul style="list-style-type: none"> 1 Simply start 2 Dashboard 3 Diagnostics 4 Display 5 Complete settings <p>Drive Id</p> <p>RDY 0.0Hz 0.00A Term -16:31</p> <p>5.6 Pump functions</p> <p>Booster Control</p> <p>PID controller</p> <p>Pump characteristics</p> <p>Pump start stop</p> <p>Pipe fill</p> <p>RDY 0.0Hz 0.00A Term -10:17</p> <p>5 Complete settings</p> <ul style="list-style-type: none"> 5.3 Define system units 5.4 Sensors Assignment 5.5 Command and Refere.. 5.6 Pump functions 5.7 Pump monitoring <p>RDY 0.0Hz 0.00A Term -16:31</p> <p>Booster Control</p> <p>Booster Control No</p> <p>System Control APR</p>
2	<p>Set [Booster Control] b C N to [Yes] Y E S:</p>  <p>RDY 0.0Hz 0.00A Term -16:32</p> <p>Booster Control</p> <p>No</p> <p>Yes ✓</p>
3	<p>A message informing you to check the PID controller configuration is displayed.</p>  <p>RDY 0.0Hz 0.00A Term -17:11</p> <p>Booster Control</p> <p>Check PID controller configuration.</p> <p>Press “OK” on the Graphic Display Terminal to confirm.</p>

Type of Control Configuration

Overview

This parameter allows defining the type of control of the booster.

In this application note, the type of control is on pressure.

Step-by-Step Configuration

The following table gives the step by step configuration for the Type of Control Configuration:

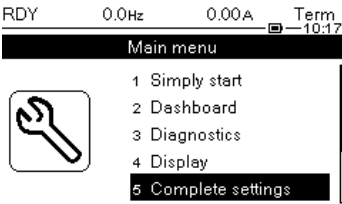
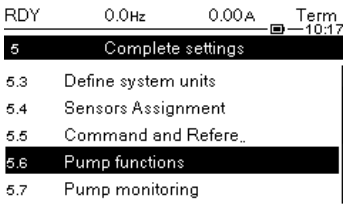
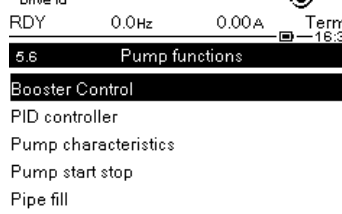
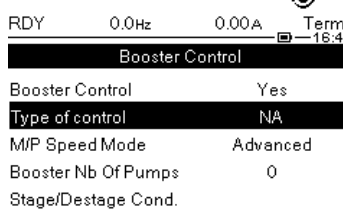
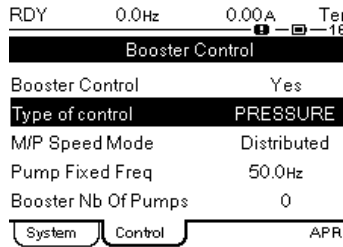
Step	Action
1	<p>Go to [Complete settings] C S E → [Pump functions] P F E → [Booster Control] b S E menu → [Booster Control] b S E tab</p>    
2	<p>Configure the parameters:</p> <ul style="list-style-type: none"> Set [Type of control] E O C E to [PRESSURE] P r E S S Set [M/P speed Mode] n P S E to [Distributed] d n C 

Stage / Destage Condition

Overview

This parameter allows to define the condition of staging / destaging

In this application note, the stage / destage condition is feedback.

Step by Step Configuration

The following table gives the step by step configuration for the Stage / Destage Condition:

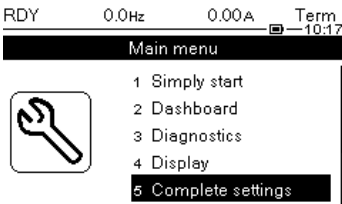
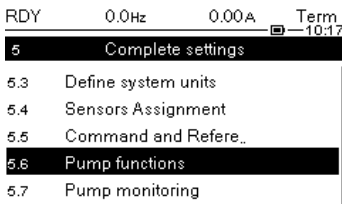
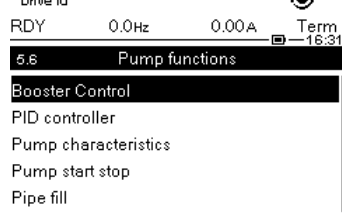
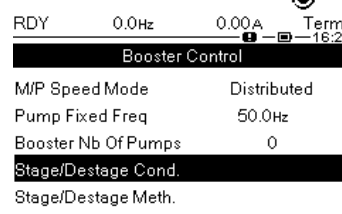
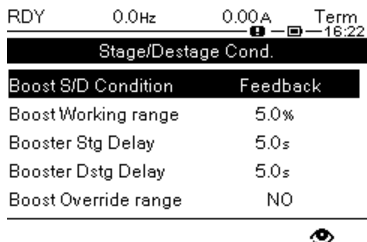
Step	Action
1	<p>Go to [Complete settings] C S E → [Pump functions] P F E → [Booster Control] b S E menu → [Booster Control] b S C tab [Stage/Destage Cond.] S D C N</p>    
2	<p>Configure the parameters:</p> <ul style="list-style-type: none"> • Set [Boost S/D Condition] b S d C to [Feedback] F b K • Set [Boost Working range] b C W R to 5.0 % • Set [Booster Stg Delay] b S d to 5.0 s • Set [Booster Dstg Delay] b d d to 5.0 s 

PID Controller

Overview

This function is activated by assigning an analog input to the PID feedback. To configure the PID, you have to scale the minimum and maximum reference values according to your application.

Step-by Step Configuration

The following table gives the step by step configuration for the PID Controller:

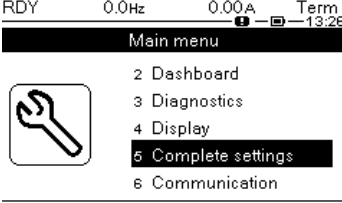
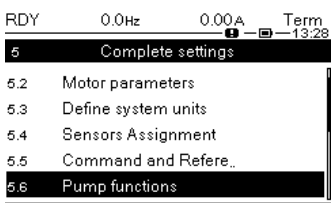
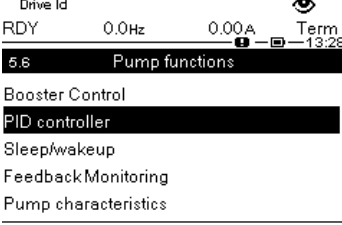
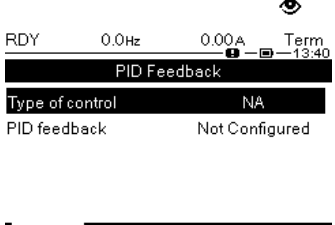
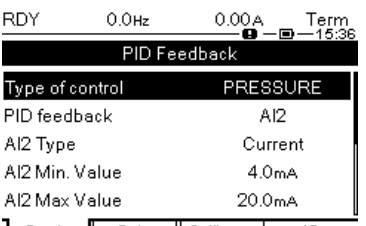
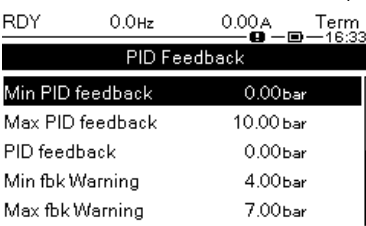
Step	Action
1	<p>Go to [Complete settings] C S E → [Pump functions] P F E → [PID controller] P , d menu [PID Feedback] P , F tab</p>    
2	<p>Configure the parameters:</p> <ul style="list-style-type: none"> • Set [Type of control] E o C E to [PRESSURE] P r E S S • Set [PID feedback] P , F to [AI2] A , 2 • Set [AI2 Type] A , 2 E to [Current] D A • Set [AI2 Min. Value] C r L 2 to 4.0 mA • Set [AI2 Max Value] C r H 2 to 20.0 mA • Set [Min PID feedback] P , F 1 to 0.00 bar • Set [Max PID feedback] P , F 2 to 10.00bar • Set [Min Fbk Warning] P A L to 4.00 bar • Set [Max Fbk Warning] P A H to 7.00 bar  

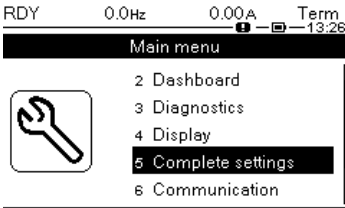
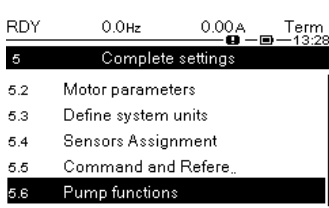
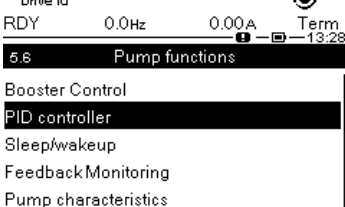
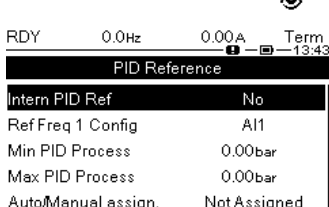
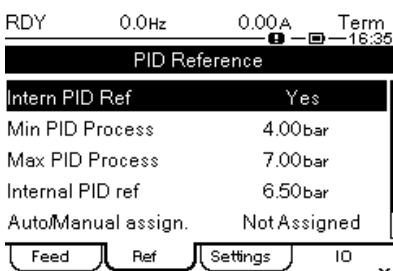
Step	Action
3	<p>Go to [Complete settings] <i>C 5 E</i> → [Pump functions] <i>P F E</i> → [PID controller] <i>P I d</i> menu [PID Reference] <i>r F</i> tab</p>    
4	<p>Configure the parameters:</p> <ul style="list-style-type: none"> • Set [Intern PID Ref] <i>P I 1</i> to [Yes] <i>Y E 5</i> • Set [Min PID Process] <i>P I P 1</i> to 4.00 bar • Set [Max PID Process] <i>P I P 2</i> to 7.00 bar • Set [Internal PID ref] <i>r P 1</i> to 6.50 bar 

Start the Application

Check the Application

Before starting the application, you have to check the parameters configuration in the Display menu.

The following table gives the step by step configuration to check the application:

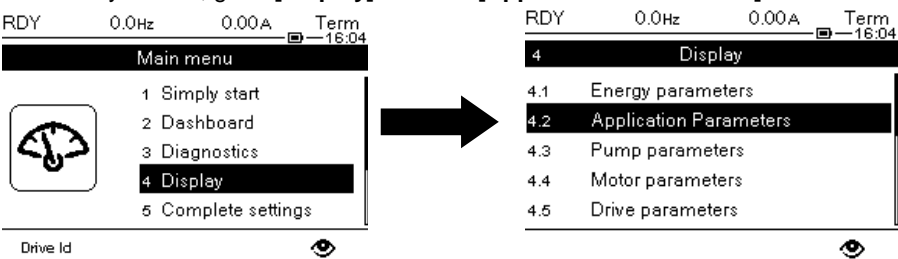
Step	Action												
1	<p>On Primary Master, go to [Display] Π α η → [Application Parameters] Α Ρ ρ menu</p>  <p>RDY 0.0Hz 0.00A Term 16:04</p> <p>RDY 0.0Hz 0.00A Term 16:04</p> <p>Drive Id</p>												
2	<p>Check the state of the following parameters:</p> <table border="1"> <thead> <tr> <th>Setting</th> <th>Verify that...</th> </tr> </thead> <tbody> <tr> <td>[System App State] Α Ρ 5 5</td> <td>The state is [Stop]. No run order on Master or Slaves</td> </tr> <tr> <td>[Application state] Α Ρ Ρ 5</td> <td>The state is [Stop]. No run order on the current device.</td> </tr> <tr> <td>[Booster Status] β Γ 5</td> <td>The state is [Inactive]</td> </tr> <tr> <td>[PID reference] ρ Ρ Γ</td> <td>The reference value is consistent according to your application</td> </tr> <tr> <td>[PID Feedback] ρ Ρ Φ</td> <td>The value is consistent.</td> </tr> </tbody> </table>	Setting	Verify that...	[System App State] Α Ρ 5 5	The state is [Stop] . No run order on Master or Slaves	[Application state] Α Ρ Ρ 5	The state is [Stop] . No run order on the current device.	[Booster Status] β Γ 5	The state is [Inactive]	[PID reference] ρ Ρ Γ	The reference value is consistent according to your application	[PID Feedback] ρ Ρ Φ	The value is consistent.
Setting	Verify that...												
[System App State] Α Ρ 5 5	The state is [Stop] . No run order on Master or Slaves												
[Application state] Α Ρ Ρ 5	The state is [Stop] . No run order on the current device.												
[Booster Status] β Γ 5	The state is [Inactive]												
[PID reference] ρ Ρ Γ	The reference value is consistent according to your application												
[PID Feedback] ρ Ρ Φ	The value is consistent.												

Start the Drives

Once the checking of the application is done, you can start the application

The following table gives the step by step configuration to start the application:

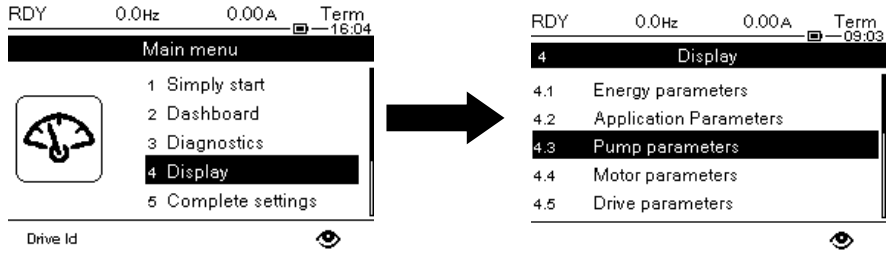
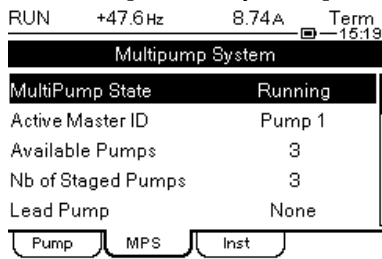
Step	Action
1	On all drives, set [DI1] <i>L I</i> to 1
2	Give a run order with the System Start Order
3	<p>On Master, go to [Display] <i>Π Π Π</i> → [Pump parameters] <i>P P P</i> menu [Multipump System] <i>Π Π Π</i> tab</p>  <p>RDY 0.0Hz 0.00A Term 16:04</p> <p>Main menu</p> <ul style="list-style-type: none"> 1 Simply start 2 Dashboard 3 Diagnostics 4 Display 5 Complete settings <p>Drive Id</p> <p>RDY 0.0Hz 0.00A Term 09:03</p> <p>4 Display</p> <ul style="list-style-type: none"> 4.1 Energy parameters 4.2 Application Parameters 4.3 Pump parameters 4.4 Motor parameters 4.5 Drive parameters
4	<p>Check that [MultiPump State] <i>Π Π Π</i> state is set to [Running] <i>r u n</i></p>  <p>RUN +47.6Hz 8.74A Term 15:19</p> <p>Multipump System</p> <p>MultiPump State Running</p> <p>Active Master ID Pump 1</p> <p>Available Pumps 3</p> <p>Nb of Staged Pumps 3</p> <p>Lead Pump None</p> <p>Pump MPS Inst</p>
5	Perform a cycle to check that the application is working properly

Part VI

Additional Parameters

Introduction

This part describes the additional steps that can be achieved to optimize the Booster Control application behavior.

In factory settings configuration, these parameters allow standard working on the application.

The values of parameters given in this part are given as example with their effects on the application.

NOTE: Settings may vary according to the architecture needs.

What is in This Part?

This part contains the following topics:

MultiDrive Link - Optional Wiring.....	43
MultiDrive Link – Errors & Warning Handling.....	45
System Architecture – Pumps Configuration	47
System Architecture – Pump Cycling Parameters	48

MultiDrive Link - Optional Wiring

Overview

The optional wiring is used to:

- Avoid two Masters to be activated in same time in case of communication interruption (e.g. avoid a redundant Master to be activated when another master is still activated but not detected due to communication interruption).

In addition, it allows to:

- Define in which order the masters will be activated (e.g. disabling master function on a drive while one of the other priority master are activated), in different order than **[M/P Device ID]** *Π Γ , Ι Δ*
- Deactivate lower priority master when a high priority master is activated.

The following diagram shows the optional wiring

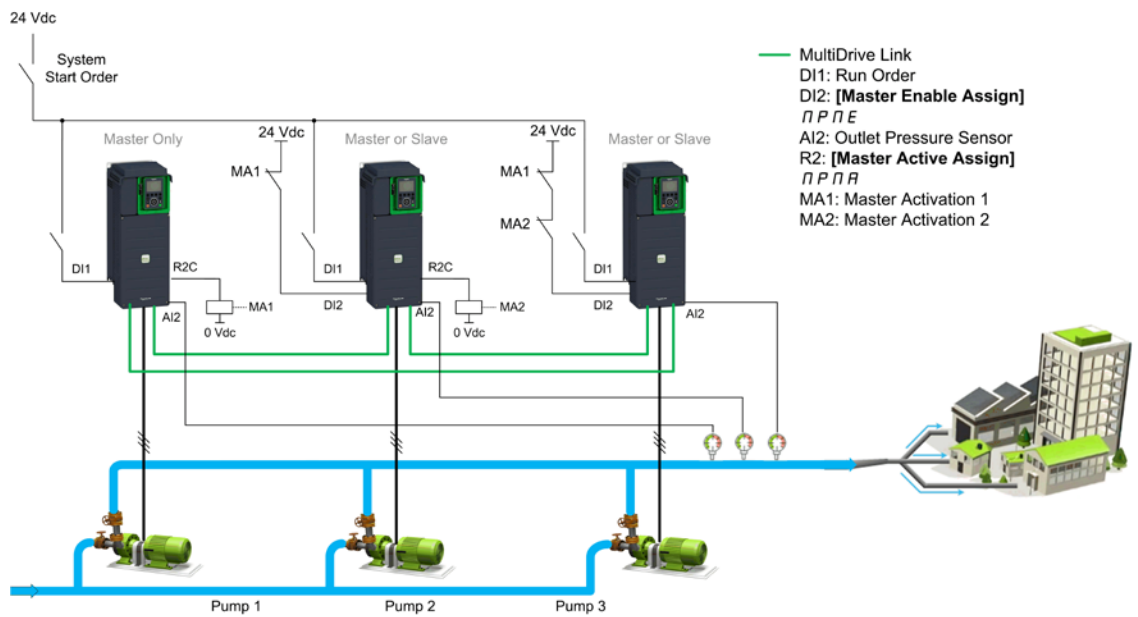

Step by Step Configuration on Primary Master

The following table gives the step by step configuration for the optional wiring on **Primary Master**:

Step	Action
1	<p>Go to [Complete settings] <i>Γ 5 E</i> → [Pump functions] <i>P F E</i> → [Booster Control] <i>β 5 E</i> → [System architecture] <i>Π Π 9</i> → [Multidrive Config] <i>Π Π V Γ</i> menu</p> <div style="display: flex; justify-content: space-around;"> <div style="border: 1px solid black; padding: 5px; width: 45%;"> <p>RDY 0.0Hz 0.00A Term -10:17</p> <p>Main menu</p> <ul style="list-style-type: none"> 1 Simply start 2 Dashboard 3 Diagnostics 4 Display 5 Complete settings <p>Drive Id RDY 0.0Hz 0.00A Term -16:31</p> <p>5.6 Pump functions</p> <p>Booster Control</p> <ul style="list-style-type: none"> PID controller Pump characteristics Pump start stop Pipe fill </div> <div style="font-size: 2em;">→</div> <div style="border: 1px solid black; padding: 5px; width: 45%;"> <p>RDY 0.0Hz 0.00A Term -10:17</p> <p>5 Complete settings</p> <ul style="list-style-type: none"> 5.3 Define system units 5.4 Sensors Assignment 5.5 Command and Refere.. 5.6 Pump functions 5.7 Pump monitoring <p>RDY 0.0Hz 0.00A Term -14:42</p> <p>System Architecture</p> <p>Pump System Archi Multi Masters</p> <p>Multidrive Config</p> <p>Pumps Configuration</p> <p>Pump Cycling Mode Runtime</p> <p>Pump Auto Cycling NO</p> <p>System Control APR</p> </div> </div>

Step	Action	
2	Set [Master Active Assign] ППНН to [R2] r 2	

Step by Step Configuration on Redundant Master

The following table gives the step by step configuration for the optional wiring on **Redundant Master**:

Step	Action	
1	Go to [Complete settings] C 5 E → [Pump functions] P F E → [Booster Control] b 5 E → [System architecture] П П 9 → [Multidrive Config] П П V C menu	
2	<ul style="list-style-type: none"> Set [Master Enable Assign] ППНН to [DI2] L 1 2 Set [Master Active Assign] ППНН to [R2] r 2 	

MultiDrive Link – Errors & Warning Handling

Overview

It is possible to configure the response to errors that the drives can detect on the MultiDrive Link architecture.

It is also possible to configure the MultiDrive Link communication timeout according to the network load of the application.

By default, these error responses are set to ramp stop to avoid water hammer effect.

In this configuration example, the error responses are changed to freewheel stop and the timeout is set to 0.20s.

A **[MultiDrive Link Error] $\Pi d L F$** error is active if the MultiDrive Link architecture is not consistent (several Masters, several Slaves with same ID) at run command. The drive response to a **[MultiDrive Link Error] $\Pi d L F$** is set with **[MultiDrive ErrorResp] $\Pi d L b$** parameter.

The **[M/P Device Error] $\Pi P d F$** error can be active only on a device which acts as a Slave. The drive response to a **[M/P Device Error] $\Pi P d F$** is set with **[M/P Device ErrorResp] $\Pi P d b$** parameter.

Master Configuration

The following table gives the step by step configuration on Master for the MultiDrive Link errors and warning:

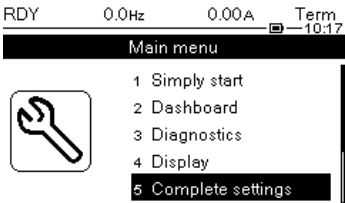
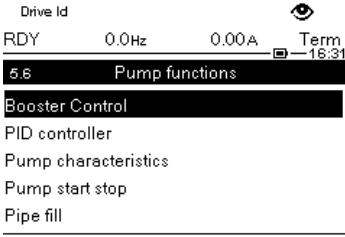
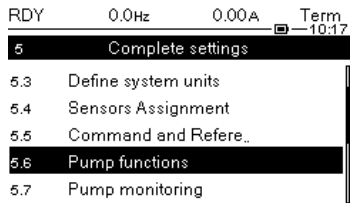
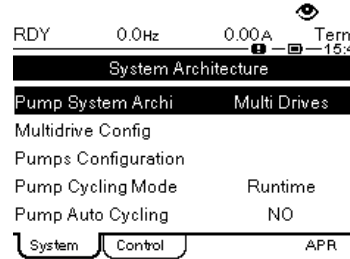
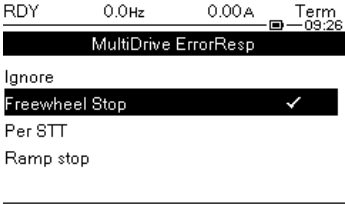
Step	Action
1	<p>Go to [Complete settings] $C S E \rightarrow$ [Pump functions] $P F E \rightarrow$ [Booster Control] $b S E \rightarrow$ [System architecture] $\Pi P 9 \rightarrow$ [Multidrive Config] $\Pi P V C$ menu</p>    
2	<p>Set [MultiDrive ErrorResp] $\Pi d L b$ to [Ramp stop] $r \Pi P$</p> 

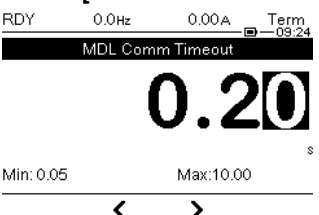
Step	Action
3	Set the [MDL Comm Timeout] <i>MDL E a</i> to 0.20s 

Slaves Configuration

The following table gives the step by step configuration on Slaves for the MultiDrive Link errors and warning:

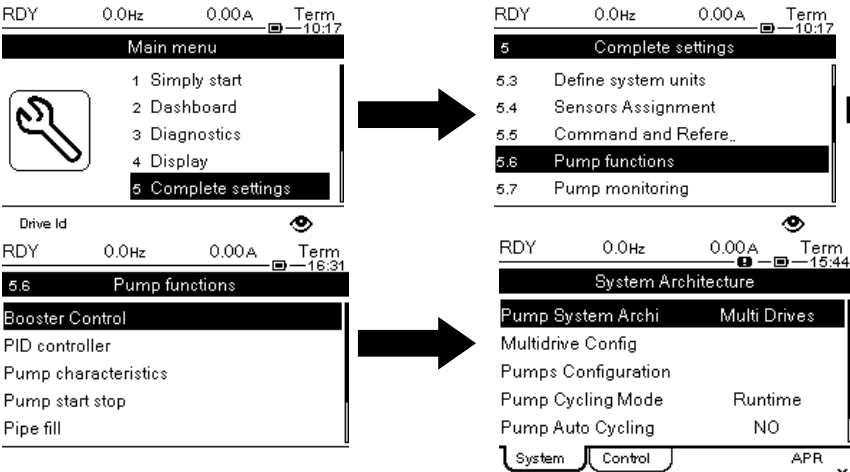
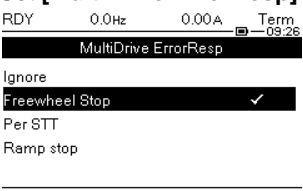
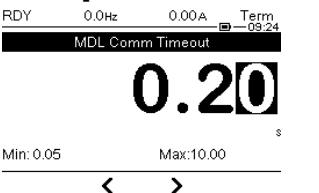
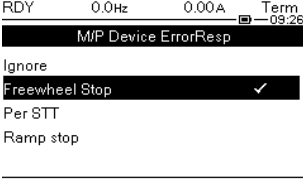
Step	Action
1	Go to [Complete settings] <i>C S E</i> → [Pump functions] <i>P F E</i> → [Booster Control] <i>b S E</i> → [System architecture] <i>PP 9</i> → [Multidrive Config] <i>PP V C</i> menu 
2	Set [MultiDrive ErrorResp] <i>MDL E</i> to [Freewheel Stop] <i>n S E</i> 
3	Set the [MDL Comm Timeout] <i>MDL E a</i> to 0.20s 
4	Set [M/P Device ErrorResp] <i>MP d E</i> to [Freewheel Stop] <i>n S E</i> 

System Architecture – Pump Cycling Parameters

Overview

This functionality allows changing the start order of the available pumps in order to manage their wear.

In this configuration example, the cycling mode is based on running time. The available pump with the lowest running time is started first and the running pump with the highest running time is stopped first.

Step by Step Configuration

The following table gives the step by step configuration for the Pump Cycling Parameters:

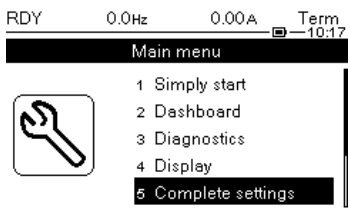
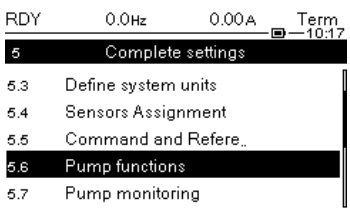
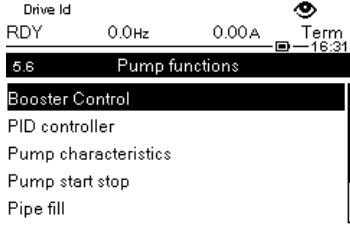
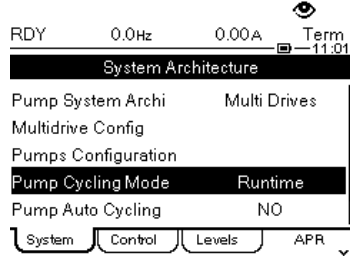
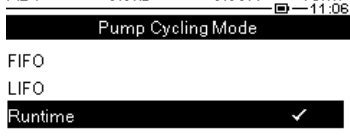
Step	Action
1	<p>Go to [Complete settings] <i>C S E</i> → [Pump functions] <i>P F E</i> → [Booster Control] <i>B S E</i> → [System architecture] <i>Π P 9</i> → [Pump Configuration] <i>P Π P</i> menu</p>    
2	<p>Set [Pump Cycling Mode] <i>Π P P C</i> to [Runtime] <i>r E i Π E</i></p> 

Part VII

Parameters Table

Introduction

The part shows all the parameters modified to allow configuration of the MultiMasters Booster Control application.

What is in This Part?

This part contains the following topics:

Parameters Table.....	50
-----------------------	----

Parameters Table

Parameters List Used in this Note

The following table shows all the parameters modified to allow configuration of the MultiMasters Booster Control application.

You can write the value for your application on the **Customer value** column.

You can use the SoMove *Altivar Process ATV600 : DTM* to store the configuration

Menu	Parameter	Application Note Setting	Customer value
[Simply start]	[Motor Standard] <i>b F r</i>	[50 Hz IEC] <i>5 0</i>	
	[Nominal Motor Power] <i>n P r</i>	5.50 kW	
	[Nom Motor Voltage] <i>u n 5</i>	400 Vac	
	[Nom Motor Current] <i>n C r</i>	11.20 A	
	[Nominal Motor Freq] <i>F r 5</i>	50.0 Hz	
	[Nominal Motor Speed] <i>n 5 P</i>	2,930 rpm	
	[Motor Th Current] <i>i t H</i>	11.20 A	
	[Acceleration] <i>A C C</i>	10.0 s	
	[Deceleration] <i>d E C</i>	10.0 s	
	[Low Speed] <i>L 5 P</i>	25.0 Hz	
	[High Speed] <i>H 5 P</i>	50.0 Hz	
[Macro Configuration]	[Application Selection] <i>A P P t</i>	[Pump Booster Control] <i>b o o 5 t</i>	
[Define system units]	[P sensor unit] <i>S u P r</i>	[0.01 Bar] <i>0 0 1 b a r</i>	
	[Flow rate unit] <i>S u F r</i>	[0.1 m3/h] <i>0 1 0 3 H</i>	
[Sensors Assignment]	[OutletPres Assign] <i>P 5 2 R</i>	[AI2] <i>A i 2</i>	
	[AI2 Type] <i>A i 2 t</i>	[Current] <i>0 A</i>	
	[AI2 Min. Value] <i>C r L 2</i>	4.0 mA	
	[AI2 Max Value] <i>C r H 2</i>	20.0 mA	
	[AI2 Lowest Process] <i>A i 2 J</i>	0	
	[AI2 Highest Process] <i>A i 2 K</i>	600	
[Eth Module Config]	[ETH Option IP Mode]	[Fixed] <i>0 A n u</i>	
	[IP address]	192.168.0.xx ⁽¹⁾	
	[Mask]	255.255.255.0	
	[Pump Curve Activate] <i>P C A</i>	[Yes] <i>Y E 5</i>	
[Booster Control]	[Pump System Archi] <i>0 P 5 A</i>	[Multi Masters] <i>n V 5 d r</i>	
	[M/P Device Role] <i>0 P d t</i>	[Master Only] <i>0 A 5 t 1</i> , [Master or Slave] <i>0 A 5 t E 2</i> and [Master or Slave] <i>0 A 5 t E 2</i> ⁽¹⁾	
	[Nb of Devices] <i>0 P G n</i>	3	
	[M/P Device ID] <i>0 G i d</i>	1, 2 and 3 ⁽¹⁾	
	[Master Active Assign] <i>0 P 0 A</i>	[R2] <i>r 2</i> ⁽²⁾	
	[Master Enable Assign] <i>0 P 0 E</i>	[DI2] <i>L i 2</i> ⁽²⁾	
	[MultiDrive ErrorResp] <i>0 d L b</i>	[Freewheel Stop] <i>n 5 t</i>	
	[MDL Comm Timeout] <i>0 L t o</i>	0.20s	

Menu	Parameter	Application Note Setting	Customer value
	[M/P Device ErrorResp] <i>Π P d b</i>	[Freewheel Stop] <i>n 5 t</i>	
	[Pump Cycling Mode] <i>Π P P C</i>	[Runtime] <i>r t , Π E</i>	
	[Type of control] <i>t o C t</i>	[PRESSURE] <i>P r E S S</i>	
	[M/P speed Mode] <i>Π P S t</i>	[Distributed] <i>d Π C</i>	
	[Boost S/D Condition] <i>b S d C</i>	[Feedback] <i>F b K</i>	
	[Booster Stg Delay] <i>b S d</i>	5.0s	
	[Booster Dstg Delay] <i>b d d</i>	5.0s	
[PID Controller]	[PID feedback] <i>P , F</i>	[AI2] <i>A , 2</i>	
	[Min PID feedback] <i>P , F 1</i>	0.00bar	
	[Max PID feedback] <i>P , F 2</i>	10.00bar	
	[Min fbk Warning] <i>P A H</i>	4.00 bar	
	[Max fbk Warning] <i>P A L</i>	7.00 bar	
	[Intern PID Ref] <i>P , ,</i>	[Yes] <i>Y E S</i>	
	[Min PID Process] <i>P , P 1</i>	4.00 bar	
	[Max PID Process] <i>P , P 2</i>	7.00 bar	
	[Internal PID ref] <i>r P ,</i>	6.50 bar	
NOTE: ⁽¹⁾ : Depend on the drive : [Master Only] <i>Π A S t 1</i> or [Master or Slave] <i>Π A S t E 2</i> . ⁽²⁾ : Optional parameters			

